

Anritsu Advancing beyond

Vector Signal Generator

MG3710E

100 kHz to 2.7 GHz
100 kHz to 4.0 GHz
100 kHz to 6.0 GHz



Multi-Band Multi-System Multi-Channel

Cut Costs for New Wireless Tests



Dual Waveform Memory

One RF output supports two waveform memories!
Combine wanted and interference signals in baseband
and output at one RF.

Dual RF

One unit supports two RF outputs!
Ideal for Multi-band, MIMO and MSR
evaluations.

RF Modulation Bandwidth: 160 MHz*/120 MHz

Can generate and output signals for 160-MHz
bandwidth max. wireless LAN (IEEE 802.11ac) and for
120-MHz bandwidth.

The MG3710E is a vector signal generator with 6-GHz upper frequency limit and 160-MHz*/120-MHz wide RF modulation baseband generator. It outputs various radio systems signals for cellular communications, such as 5G, LTE FDD/TDD, W-CDMA, GSM as well as narrowband communications, such as WLAN, Bluetooth and GPS.

Cuts Equipment Costs

The dual waveform memory cuts equipment costs for tests, such as ACS, Blocking and IM, which require two modulation signal sources. The dual RF cuts MIMO equipment costs and reduces workloads for phase synchronization between equipment. It is important for tests using separate signals, such as MSR and multi-band.

Improves Yield

The high quality signal generator ACLR and SSB phase noise reduces the effect on wideband and narrow-band measurements to improve test margins and yields.

-68 dBc @W-CDMA, TestModel1, 64DPCH, 2 GHz
<-140 dBc/Hz (nom.) @100 MHz, 20 kHz offset, CW

Cuts Tact Time

The List/Sweep mode switches the frequency and level faster than 600 μ s. Moreover, the 4-GB waveform memory upgrade can load many waveform patterns while instantaneous switching eliminates time wasted reloading waveform patterns.

*: Supports firmware version 2.00.00 and later. Can generate 160-MHz bandwidth signals (Wireless LAN IEEE 802.11ac) only when using WLAN IQproducer MX370111A and 802.11ac (160 MHz) option MX370111A-002. The latest version can be downloaded from the Anritsu homepage. <<https://my.anritsu.com/home>>

Vector Signal Generator MG3710A/MG3710E

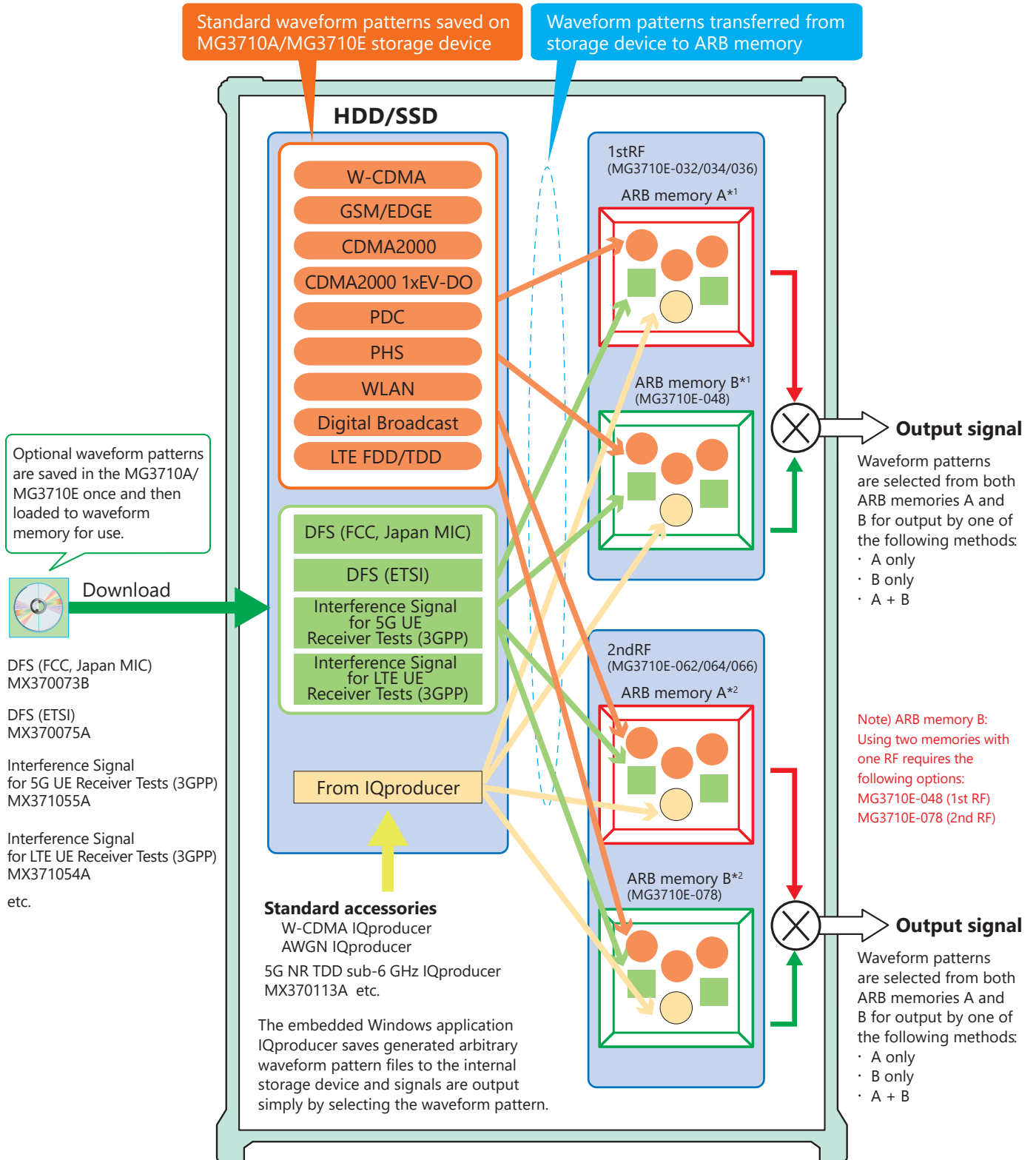

*1: 1stRF ARB memory size

- 256 MB × 1 pc = 64 Msamples (Std.)
- 1 GB × 1 pc = 256 Msamples × 1 pc (MG3710E-045)
- 1 GB × 2 pcs = 256 Msamples × 2 pcs (MG3710E-045 + MG3710E-048)
- 4 GB × 1 pc = 1024 Msamples × 1 pc (MG3710E-046)
- 4 GB × 2 pcs = 1024 Msamples × 2 pcs (MG3710E-046 + MG3710E-048)

*2: 2ndRF ARB memory size

- 256 MB × 1 pc = 64 Msamples (Std.)
- 1 GB × 1 pc = 256 Msamples × 1 pc (MG3710E-075)
- 1 GB × 2 pcs = 256 Msamples × 2 pcs (MG3710E-075 + MG3710E-078)
- 4 GB × 1 pc = 1024 Msamples × 1 pc (MG3710E-076)
- 4 GB × 2 pcs = 1024 Msamples × 2 pcs (MG3710E-076 + MG3710E-078)

Key Features

Dual RF & Dual Waveform Memory

One Unit Supports Two RF Outputs Max.

Frequency Range

- 1stRF: 100 kHz to 2.7/4.0/6.0 GHz [MG3710E-032/034/036]
- 2ndRF: 100 kHz to 2.7/4.0/6.0 GHz [MG3710E-062/064/066]

Independent Baseband and RF Outputs

Output Two Signals from One RF Out [MG3710E-048/078]

The baseband signal combine option installs two waveform memories for either the 1stRF (or 2ndRF) SG to combine two waveform patterns as the baseband for output, eliminating the need for two separate and expensive vector signal generators.

- Wanted Signal + Interfere Signal
- Wanted Signal + Delayed Signal, etc.

Basic Performance

ACLR Performance

-68 dBc @W-CDMA, TestModel1, 64 DPCH, 2 GHz

High-power Output [MG3710E-041/071]

+23 dBm @CW, 400 MHz to 3 GHz

High-speed Switching

<600 μ s @List/Sweep mode

High Level Accuracy

Absolute Level Accuracy: ± 0.5 dB
Linearity: ± 0.2 dB (typ.)

Choice of Reference Oscillators

Standard

Aging rate $\pm 1 \times 10^{-6}$ /year, $\pm 1 \times 10^{-7}$ /day

High Stability Reference Oscillator [MG3710E-002]

Aging rate $\pm 1 \times 10^{-7}$ /year, $\pm 1 \times 10^{-8}$ /day

Rubidium Reference Oscillator [MG3710E-001]

Aging rate $\pm 1 \times 10^{-10}$ /month

SSB Phase Noise Performance

- <-140 dBc/Hz (nom.) @100 MHz, 20-kHz offset, CW
- <-131 dBc/Hz (typ.) @1 GHz, 20-kHz offset, CW
- <-125 dBc/Hz (typ.) @2 GHz, 20-kHz offset, CW

Single sideband phase noise

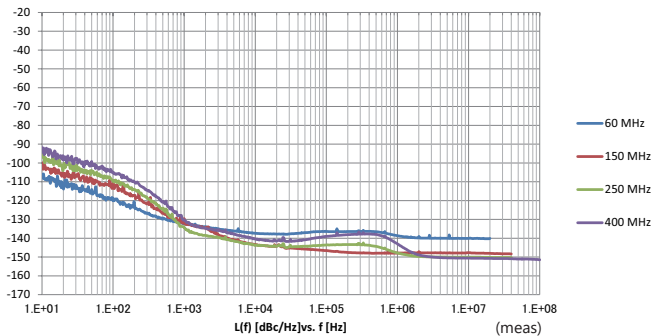

High All-purpose Baseband Performance

Wide Vector Modulation Bandwidth

- 160 MHz*/120 MHz (using Internal baseband signal generator)
- 160 MHz (using External IQ input)

*: Supports firmware version 2.00.00 and later. Can generate 160-MHz bandwidth signals (Wireless LAN IEEE 802.11ac) only when using WLAN IQproducer MX370111A and 802.11ac (160 MHz) option MX370111A-002.

Large-capacity Waveform Memory

- 64 Msamples [with 1stRF, 2ndRF]
- 256 Msamples [MG3710E-045/075]
- 1024 Msamples [MG3710E-046/076]

Arbitrary Waveform Generation

ASCII IQ sample data created using general-purpose signal generation software (such as MATLAB) can be converted to waveform patterns for the MG3710E. Data produced during R&D simulations can be converted using IQproducer.

Expandability

BER Test Function [MG3710E-021]

This option measures BER using Data/Clock/Enable demodulated at the DUT to display the results on the MG3710E screen.

Input bit rate: 100 bps to 40 Mbps

Analog/Pulse Modulation Functions [Standard]

Supports built-in analog modulation (AM/FM/ Φ M) functions and pulse modulation (PM) functions.

Adding additional analog modulation input options (MG3710E-050/080) supports modulation by external signal input.

AWGN Generator [MG3710E-049/079]

This options generates AWGN internally for the required waveform.

Absolute CN Ratio: ≤ 40 dB

USB Power Sensors [Sold separately]

Up to two USB power sensors can be connected to the MG3710E and the results are displayed on the MG3710E screen.

- Frequency Range: 50 MHz to 6 GHz [MA24106A]
- 10 MHz to 18 GHz [MA24118A]
- 10 MHz to 26 GHz [MA24126A] etc.

Local Signal I/O for MIMO Signal Source [MG3710E-017]

Local signals, baseband clocks and trigger signals can be shared between up to four MG3710E units to output phase coherency signals with synchronized signal output timing for configuring even 8x8 MIMO systems.

Key Features

Operability

Simple Touch-panel Operation

Touching the easy-to-use GUI with hierarchical menus fetches related function and numeric input keys for simple fast settings.

Signal Flowcharts with Signal Block Diagrams

Two intuitive Hardware Block Chart and ARB Info screens make it easy to grasp settings, data and signal paths at a glance.

Frequency Channel Table

A built-in channel table with presets for popular communications systems simplifies frequency settings by using channel numbers.

Connections with External Equipment

Remote Control Interfaces

GPIO, Ethernet (1000BASE-T), and USB (Type B) interfaces on the rear panel offer versatile choices for operation by remote control.

USB Connections

Two Type A USB2.0 connectors on each of the front and rear panels offer convenient connections for keyboard, mouse and USB memory.

Analog IQ Input/Output [MG3710E-018]

This option installs analog IQ input and output connectors on the front and rear panels, respectively.

Input: I Input, Q Input

Output: I Output, \bar{I} Output, Q Output, \bar{Q} Output,

Trigger Input

Start and Frame trigger connectors are built-in in as standard for outputting waveform patterns synchronized with externally input trigger signals.

Marker Output Editing

Marker 1 output [Standard]

Marker 2 and 3 output [Requires AUX Conversion Adapter J1539A]

This standard function outputs trigger signals at specific positions in the waveform pattern (Frame header, Burst header, etc.) for synchronizing and measuring signal generator waveform patterns with external equipment. Preset markers can be set at both the pre-installed waveform patterns and waveforms generated using IQproducer and any set markers can be output with the MG3710E marker editing function.

Pre-installed Key Waveform Patterns

Waveform Patterns [Pre-installed]

Waveform patterns for the world's main communications systems (below) are pre-installed in the MG3710E for license-free use.

- LTE FDD (E-TM1.1 to E-TM3.3)
- LTE TDD (E-TM1.1 to E-TM3.3)
- W-CDMA/HSDPA
- GSM/EDGE
- CDMA2000 1X/1xEV-DO
- Bluetooth®
- GPS
- PDC
- PHS
- Digital Broadcast (ISDB-T/BS/CS/CATV)
- WLAN (IEEE 802.11a/11b/11g)

Waveform Pattern Options and Generation

Optional Waveform Pattern [Optional License]

- DFS Radar Pattern (For FCC & Japan MIC)
- DFS (ETSI) Waveform Pattern
- ISDB-Tmm Waveform Pattern
- Interference Signal for 5G UE Receiver Tests Waveform Pattern
- Interference Signal for LTE UE Receiver Tests Waveform Pattern

IQproducer Waveform Generation Software [Optional License]

- 5G NR TDD sub-6 GHz
- 5G NR FDD sub-6 GHz
- LTE FDD/LTE-Advanced FDD
- LTE TDD/LTE-Advanced TDD
- HSDPA/HSUPA/W-CDMA
- TD-SCDMA
- WLAN 11a/b/g/n/j/p/ac
- TDMA (PDC, PHS, Public Radio System.)
- DVB-T/H
- Multi-carrier
- Fading

Dual RF & Dual Waveform Memory

Dual VSG: Two RF Outputs

The MG3710E supports two RF outputs (1stRF/2ndRF) max. in one unit. Moreover, different frequencies can be set independently at 1stRF and 2ndRF.

Not only different frequencies but also different levels and waveform patterns can be set independently at each SG while each is tracking the other. This is convenient in the R&D phase for evaluating interference between two different systems using different frequency bands.

Notes: Supported frequency bands cannot be changed after shipment.
 IQ input is supported only by SG1 (1stRF) and requires MG3710E-017.

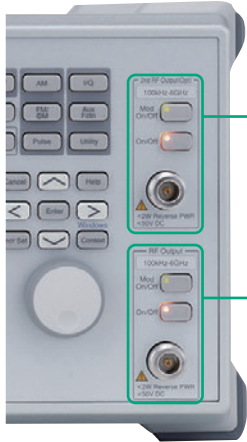

- 2ndRF**
 Frequency Range:
 2ndRF 100 kHz to 2.7 GHz [MG3710E-062]
 2ndRF 100 kHz to 4.0 GHz [MG3710E-064]
 2ndRF 100 kHz to 6.0 GHz [MG3710E-066]
 * Whether or not install and the frequency model can be selected at any time.
- 1stRF**
 Frequency Range:
 1stRF 100 kHz to 2.7 GHz [MG3710E-032]
 1stRF 100 kHz to 4.0 GHz [MG3710E-034]
 1stRF 100 kHz to 6.0 GHz [MG3710E-036]
 * Must install any one of these.

Dual Waveform Memory: Four Waveform Outputs Max.

In the standard configuration, one VSG (1stRF or 2ndRF) has one waveform memory. However, adding the baseband signal combine option (MG3710E-048/078) upgrades to two memories for one VSG. In other words, models with two VSGs (1stRF and 2ndRF) installed can have a maximum of four waveform memories. Two waveform patterns can be set easily on-screen for one VSG, each with different frequency offset, level offset and delay time settings to output a combined baseband RF signal. With this setup, one MG3710E supports the following test environment — a setup that previously required two expensive signal generators:

- Wanted Signal + Interference Signal
- Wanted Signal + Delayed Signal

Synthesizing Signals with Different Sampling Rates

~ Rate Matching Function ~

When signals with different sampling rates are set in memory A and memory B, a synthesized signal maintaining each of the different sampling rates can be output. This is useful when synthesizing signals for standards with different rates, such as multi-standard signals.

However, depending on the combination of waveform sampling rates, sometimes it may not be possible to match rates due to internal operation clock limitations. The Mismatch warning dialog is displayed in this case.

- Waveform Pattern A**
 Example:
 Wanted Signal
- Waveform Pattern B**
 Example:
 Interference Signal,
 Delayed Signal

Level Setting
 Setting Range: -80 to +80 dB
 Resolution: 0.01 dB

Frequency Offset Setting
 Setting Range: -100 to +100 MHz
 Resolution: 1 Hz

Center Frequency Selection
 A: Pattern A center
 B: Pattern B center
 Baseband DC:
 Centered at baseband DC position

Time Offset Setting
 Setting Range:
 0 ~ pattern B sampling data count - 1

Baseband Signal Combine Example

Dual RF & Dual Waveform Memory

Example of Baseband Signal Combine Output



Wanted + Modulated Interference Signals

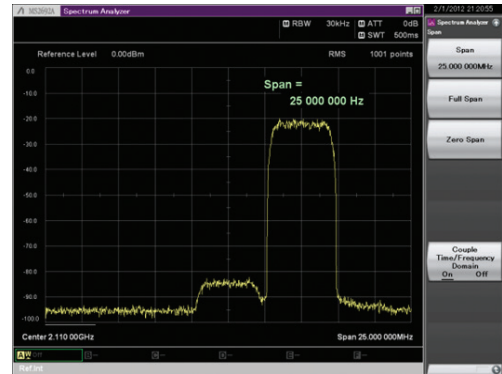

Spectrum of
Wanted + Modulated Interference Signals



Wanted + Delayed Signals

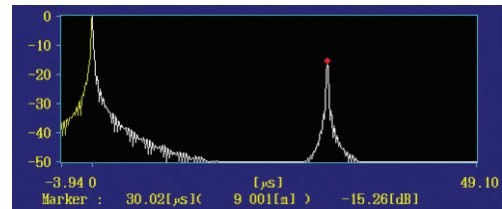

Delay Profile of
Wanted + Delayed Signals

Basic Performance

Vector Accuracy (EVM)

W-CDMA (Test Model 4)

Output Frequency: 800 MHz to 900 MHz, 1.8 GHz to 2.2 GHz
 $\leq 0.62\%$ (rms)
 $\leq 0.6\%$ (rms) (typ.)

LTE (20 MHz Test Model 3.1)

Output Frequency: 600 MHz to 2.7 GHz, 3.4 GHz to 3.8 GHz
 $\leq 0.82\%$ (rms)
 $\leq 0.8\%$ (rms) (typ.)

High-power Output [MG3710E-041*1/071*2]

*1: High Power Extension for 1stRF [MG3710E-041]

*2: High Power Extension for 2ndRF [MG3710E-071]

Level Accuracy is assured at high levels (CW)

Frequency Range	Standard	MG3710E-041/071
100 kHz \leq f < 10 MHz	+5 dBm	+5 dBm
10 MHz \leq f < 50 MHz	+10 dBm	+10 dBm
50 MHz \leq f < 400 MHz	+13 dBm	+20 dBm
400 MHz \leq f \leq 3 GHz		+23 dBm
3 GHz < f \leq 4 GHz		+20 dBm
4 GHz < f \leq 5 GHz	+11 dBm	+13 dBm
5 GHz < f \leq 6 GHz		+11 dBm

These options expand the MG3710E RF output upper limit. They are used when compensating for level losses of parts in the measurement path.

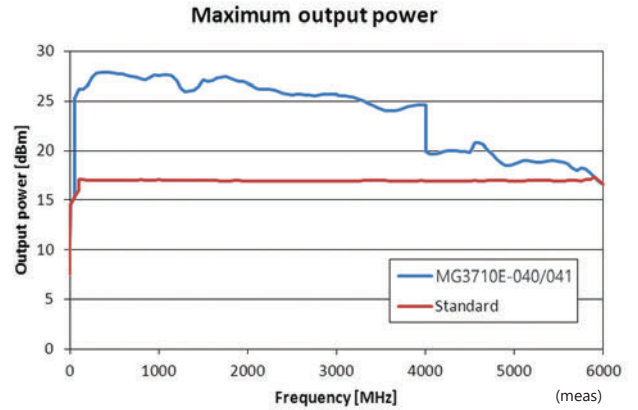

Basic Performance

SSB Phase Noise

- <-140 dBc/Hz (nom.) @100 MHz, 20-kHz offset, CW
- <-131 dBc/Hz (typ.) @1 GHz, 20-kHz offset, CW
- <-125 dBc/Hz (typ.) @2 GHz, 20-kHz offset, CW

SSB phase noise is an important performance index for signal generators. For example, when using a signal generator for the following purposes, it is important to pre-confirm that the signal generator performance satisfies the measurement specifications.

- Communications with narrow bandwidth of several kHz
- OFDM Signals with narrow subcarrier gap
- CW interference waveforms

Single sideband phase noise

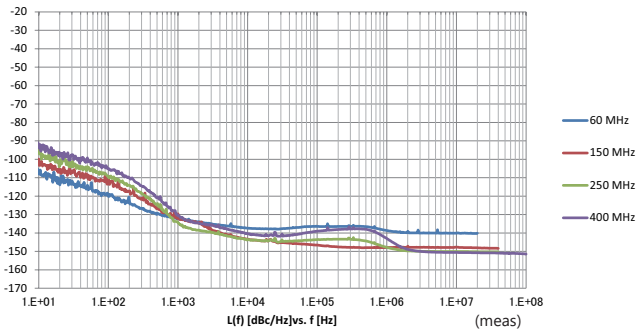

Single sideband phase noise

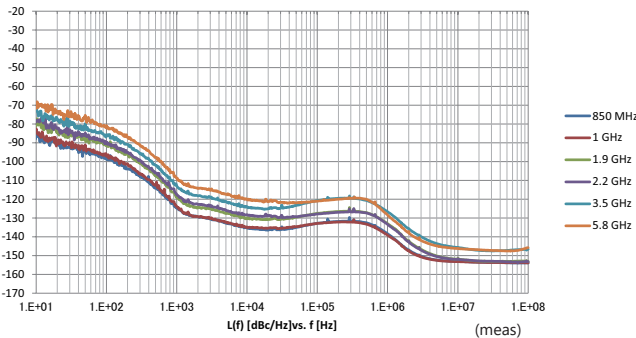

SSB Phase Noise
(Phase Noise Optimization <200 kHz, CW, Optimize S/N Off, with MG3710E-002)

High-speed Switching

<600 μs @List/Sweep mode

To shorten tact times on production lines the MG3710E supports two standard modes each with high-speed frequency and level switching.

Sweep Mode

In this mode, the dwell time per point or number of points is split between the frequency range and level range (Start/Stop). This mode is used when matching dwell time per point and frequency/level steps.

- Frequency Range:** 400 0000000 MHz to 500 0000000 MHz
- Level Range:** -10.00 dBm to -50.00 dBm
- Points:** 10
- Dwell Time:** 500 μs
- Step Shape:** Sawtooth, Triangle

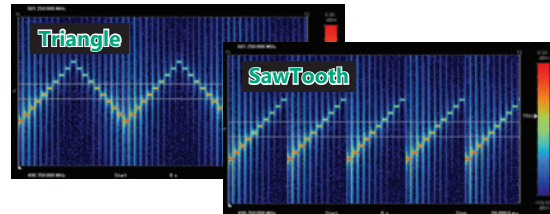

10 points, 500-μs Dwell Time

List Mode

In this mode, the frequency, level and dwell time can be set for each of up to 500 points. This mode is used when wanting to set any dwell time, and frequency/level step per point.

Point	Frequency	Level	Dwell
1	400 0000000 MHz	-10.00 dBm	500 μs
2	400 0000000 MHz	-20.00 dBm	5 μs
3	500 0000000 MHz	-10.00 dBm	5 μs
4	500 0000000 MHz	-20.00 dBm	5 μs
5	500 0000000 MHz	-10.00 dBm	5 μs

5 points, Any Dwell Time

Basic Performance

High Level Accuracy

Absolute Level Accuracy: ± 0.5 dB*1

Linearity: ± 0.2 dB (typ.)*2

*1: 400 MHz to 3 GHz, -110 to +10 dBm

*2: 50 MHz to 3 GHz, -110 to -1 dBm

Excellent level accuracy and linearity are key factors with a large impact on measurement accuracy.

Level accuracy at -112 dBm

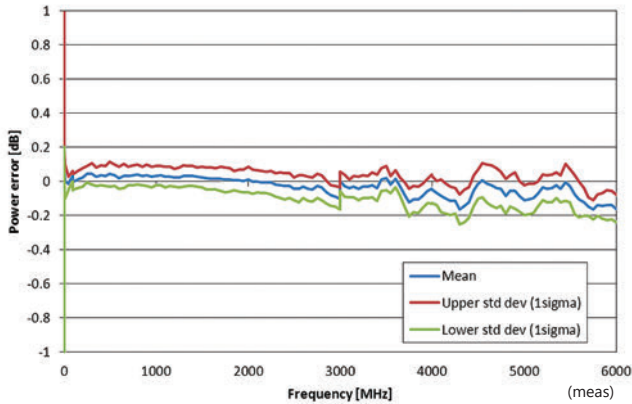

Frequency Characteristic

Relative level accuracy at 850 MHz initial power +10 dBm

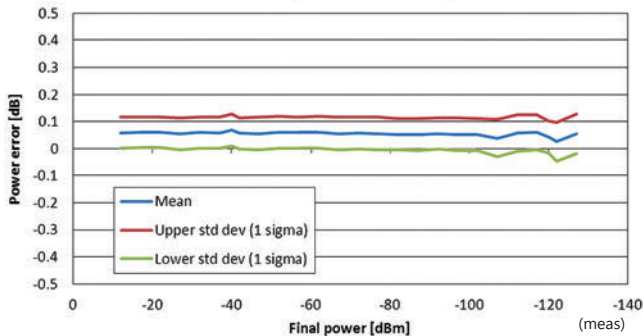

Linearity

Amplitude repeatability +5 dBm ALC on

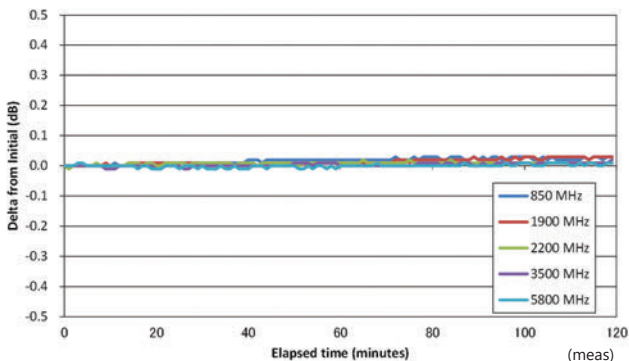

Aging

Supports Rubidium Reference Oscillator (Option)

Three reference oscillator options are supported. Select the high-stability reference oscillator option [MG3710E-002] when requiring high accuracy depending on the measurement conditions; for even higher accuracy, select the rubidium reference oscillator [MG3710E-001]. However, if external high-accuracy reference signals are available, selecting the standard reference oscillator option helps reduce unnecessary costs.

Reference Oscillator

- Standard
 - Aging Rate: $\pm 1 \times 10^{-6}$ /year, $\pm 1 \times 10^{-7}$ /day
 - Temperature Stability: $\pm 2.5 \times 10^{-6}$ (5°C to 45°C)
- High Stability Reference Oscillator [MG3710E-002]
 - Aging Rate: $\pm 1 \times 10^{-7}$ /year, $\pm 1 \times 10^{-8}$ /day
 - Temperature Stability: $\pm 2 \times 10^{-8}$ (5°C to 45°C)
 - Start-up Characteristics*: $\pm 5 \times 10^{-7}$ (2 minutes after power-on)
 - $\pm 5 \times 10^{-8}$ (5 minutes after power-on)

Rubidium Reference Oscillator [MG3710E-001]

- Aging Rate: $\pm 1 \times 10^{-10}$ /month
- Temperature Stability: $\pm 2 \times 10^{-9}$ (5°C to 45°C)
- Start-up Characteristics*: $\pm 1 \times 10^{-9}$ (7.5 minutes after power-on)

*: Compared to frequency after 24-h warm-up at 23°C

High All-purpose Baseband Performance

Wide Vector Modulation Bandwidth

160 MHz*/120 MHz (using Internal baseband signal generator)

160 MHz (using External IQ input)

Using the standard internal baseband signal generator offers a wide vector modulation bandwidth of 160 MHz.

*: Supports firmware version 2.00.00 and later. Can generate 160-MHz bandwidth signals (Wireless LAN IEEE 802.11ac) only when using WLAN IQproducer MX370111A and 802.11ac (160 MHz) option MX370111A-002. The latest version can be downloaded from the Anritsu homepage. <<https://my.anritsu.com/home>>

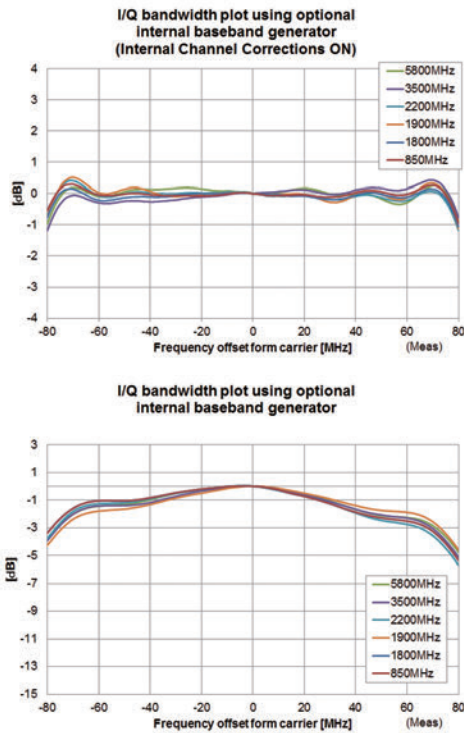

Point:

One unit supports WLAN IEEE 802.11ac signal generation and output !

- Upper Frequency Limit: 6 GHz
- RF Modulation Bandwidth: 160 MHz
- Dual RF: Two RF Outputs
- Waveform Generation Software
- WLAN IQproducer (MX370111A & MX370111A-002)

The MG3710E supports output from 160-MHz bandwidth signals to non-contiguous 80 MHz + 80 MHz signals in one unit, which generally requires two signal generators.

Example: Support IEEE 802.11ac signal generation and output

11ac Bandwidth	20/40/80/160 MHz	80 MHz + 80 MHz (non-contiguous)
MG3710E*1	✓	✓*2

*1: WLAN IQproducer MX370111A and 802.11ac (160 MHz) option MX370111A-002 installed. For detail, refer to the IQproducer catalog.
 *2: 2ndRF option MG3710E-062 (2.7 GHz)/064 (4 GHz)/066 (6 GHz) installed.

Free Waveform Generation

ASCII-format IQ sample data files created by other general-purpose EDA tools, such as MATLAB, can be converted into MG3710E waveform pattern files. Support for customer waveform pattern file creation makes the MG3710E ideal for R&D simulation applications too.

Large-capacity Waveform Memory

64 Msamples (256 MB) [with 1stRF, 2ndRF]

256 Msamples (1 GB) [MG3710E-045*/075*2]

1024 Msamples (4 GB) [MG3710E-046*/076*2]

*1: ARB Memory Upgrade 256 Msample for 1stRF [MG3710E-045]
 ARB Memory Upgrade 1024 Msample for 1stRF [MG3710E-046]

*2: ARB Memory Upgrade 256 Msample for 2ndRF [MG3710E-075]
 ARB Memory Upgrade 1024 Msample for 2ndRF [MG3710E-076]

Memory size is the most important specification for arbitrary waveform memory. If the memory is small, large waveform patterns cannot be handled and the number of cases when multiple waveform patterns cannot be loaded increases. When this happens, the time to reload another waveform pattern wastes evaluation time and lowers efficiency. The MG3710E has a large 64 Msamples memory as standard and this can be upgraded to either 4 times (256 Msamples) or 16 times (1024 Msamples) by adding these options.

Point:

Adding the baseband signal combine function (MG3710E-048/078) supports waveform memories which can either be used separately or linked to multiply the memory size.

*: When attempting to load a waveform pattern exceeding the size of one memory, the memories are linked automatically to load the large pattern. However, in this case, other waveform patterns cannot be loaded into any remaining free space. When dealing with many waveform patterns, we recommend upgrading the ARB memory size. If the waveform pattern can be handled by one memory, other waveform patterns can be loaded into the remaining free space and the other memory. The maximum size per waveform pattern supported by the MG3710E varies with the IQproducer version.

Maximum Waveform Pattern Size and Required Options for Simultaneous Use

1stRF (MG3710E-032/034/036)

Combination of Baseband Signal (MG3710E-048)	ARB Memory Upgrade 256 Msample (MG3710E-045) ARB Memory Upgrade 1024 Msample (MG3710E-046)		
	W/O	With MG3710E-045	With MG3710E-046
W/O	64 Msamples × 1 pc	256 Msamples × 1 pc	1024 Msamples × 1 pc*1
With MG3710E-048*2	64 Msamples × 2 pcs 128 Msamples × 1 pc	256 Msamples × 2 pcs 512 Msamples × 1 pc	1024 Msamples × 2 pcs*1

2ndRF (MG3710E-062/064/066)

Combination of Baseband Signal (MG3710E-078)	ARB Memory Upgrade 256 Msample (MG3710E-075) ARB Memory Upgrade 1024 Msample (MG3710E-076)		
	W/O	With MG3710E-075	With MG3710E-076
W/O	64 Msamples × 1 pc	256 Msamples × 1 pc	1024 Msamples × 1 pc*1
With MG3710E-078*2	64 Msamples × 2 pcs 128 Msamples × 1 pc	256 Msamples × 2 pcs 512 Msamples × 1 pc	1024 Msamples × 2 pcs*1

*1: The maximum size per waveform pattern supported by the MG3710E varies with the IQproducer version.

*2: The Baseband Signal Combine option supports two ARB memories and can either set two different waveform patterns or combine them as one memory to support one large waveform pattern.

Expandability

BER Test Function [MG3710E-021]

This option installs a BER measurement function for measuring error rates between 100 bps and 40 Mbps using the DUT demodulated Data/Clock/Enable signals. The results are displayed on the MG3710E screen.

Input Bit Rate: 100 bps to 40 Mbps

Input Signal: Data, Clock, Enable (Polarity reversal supported)

Input Level: TTL

Measured Patterns:

PN9/11/15/20/23, ALL1, ALL0, Alternate (0101...), User Data, PN9fix/11fix/15fix/20fix/23fix

Count Mode

Data: Measures until specified Data count
Error: Measures until specified Error count

Measurable Bit Count: $\leq 2^{32} - 1$ (4,294,967,295 bits)

Measurement Mode

Single: Measures specified measurement bit count once
Continuous: Repeats Single measurement
Endless: Continues measurement to upper limit of measurement bits

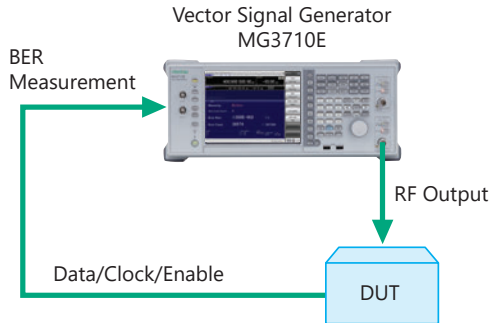

The BER can be measured using the DUT-demodulated Data/Clock/Enable.

BER Measurement Upper Limit

The table below shows one example of a BER measurement that indicates SyncLoss. Actual results depend on the specific communication systems and data rate, and will not necessarily match the measurement values below.

Error Rate	PN9	PN11	PN15	PN20	PN23
6.0%	-	-	-	-	-
5.0%	ok	-	-	-	-
4.0%	ok	ok	-	-	-
3.0%	ok	ok	ok	-	-
2.5%	ok	ok	ok	-	-
2.0%	ok	ok	ok	ok	ok
1.0%	ok	ok	ok	ok	ok

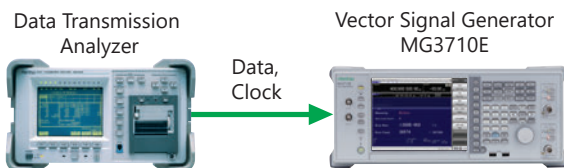

AM/FM/ΦM/PM Function

This option supports the following modulation functions as standard. Analog modulations (AM/FM/ΦM) are performed on CW signals or arbitrary (ARB) waveform pattern signals.

Pulse modulation can be performed at any cycle or timing and also supports modulation using an external input signal.

Amplitude Modulation (Internal Modulation Source)

Depth: 0 to 100% (Linear)
0 to 10 dB (Exponential)
Modulation Frequency: 0.1 Hz to 50 MHz

Frequency Modulation (Internal Modulation Source)

Deviation: 0 to 40 MHz
Modulation Frequency: 0.1 Hz to 40 MHz, or (50 MHz-FM Rate), whichever smaller

Φ-Modulation (Internal Modulation Source)

Deviation angle: 0 to 160 rad.
or (40 MHz/ΦM Rate) rad., whichever smaller
Modulation Frequency: 0.1 Hz to 40 MHz, or (40 MHz/ΦM Deviation), whichever smaller

Pulse Modulation (Internal Modulation Source)

Modulation Frequency: 0.1 Hz to 10 MHz
Modulation Period: 10 ns to 20 s

Additional Analog Modulation Input [MG3710E-050/080]

Adding additional analog modulation input options (MG3710E-050/080) extends to two internal modulation sources (AM/FM/ΦM) and one external modulation source supporting simultaneous two-signal modulation.

- AM + FM
- AM + ΦM
- Internal 1 + Internal 2
- Internal + External

*: FM + ΦM does not support.

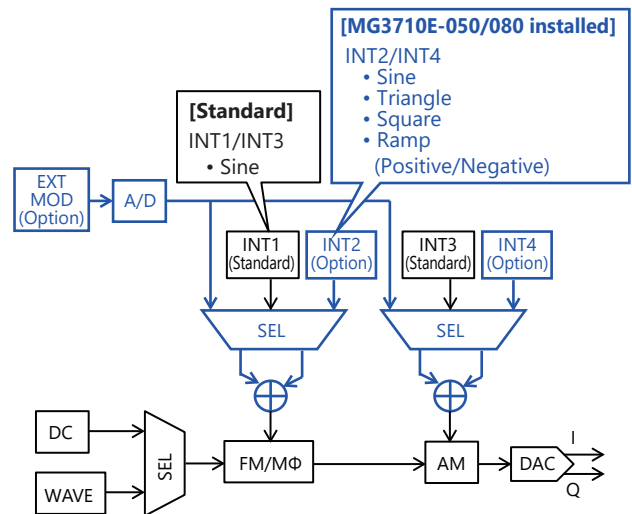

Expandability

AWGN Generator [MG3710E-049*1/079*2]

- *1: AWGN for 1stRF [MG3710E-049]
- *2: AWGN for 2ndRF [MG3710E-079]

This option adds internally generated AWGN to the wanted signal. The AWGN output is switched on and off just by pressing the On/Off button.

Absolute C/N Ratio: ≤40 dB

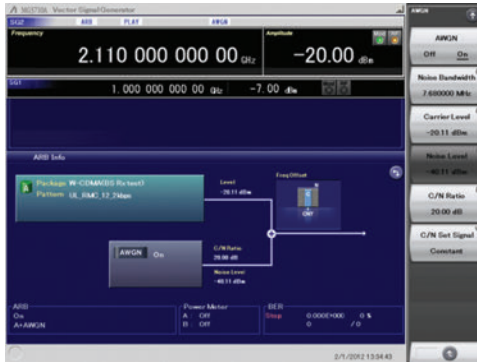

AWGN Signal Addition Screen

USB Power Sensors [Sold separately]

Up to two USB power sensors can be connected to the MG3710E to display the measurement results on the MG3710E screen.

USB Power Sensor

Model	Frequency Range	Dynamic Range
MA24104A*	600 MHz to 4 GHz	+3 to +51.76 dBm
MA24105A	350 MHz to 4 GHz	+3 to +51.76 dBm
MA24106A	50 MHz to 6 GHz	-40 to +23 dBm
MA24108A	10 MHz to 8 GHz	-40 to +20 dBm
MA24118A	10 MHz to 18 GHz	-40 to +20 dBm
MA24126A	10 MHz to 26 GHz	-40 to +20 dBm

*: MA24104A has been discontinued. Replacement model is MA24105A.

- Level Offset: -100 to +100 dB
- Average: 1 to 2048
- Unit: dBm, W
- COM Port: 2 to 8

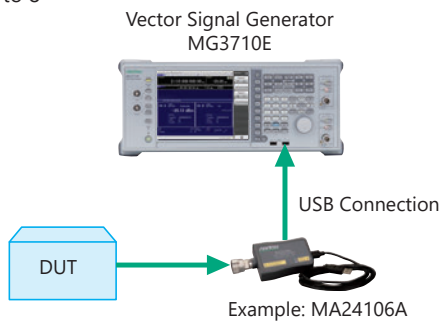

Power Meter Measurement Screen

Checking Com Port:

1. Display Windows
Press [Shift] + [Context (Windows)] or Right-click mouse > Show Desktop
2. Display Device Manager
Start > My Computer > Properties > Hardware > Device Manager
3. Check Ports (COM & LPT)



Local Signal I/O for MIMO Signal Source [MG3710E-017]

The Sync Multi SG function shares local, baseband and trigger signals between multiple MG3710E units to output phase coherency signals synchronized with the signal output timing.

An 8x8 MIMO test system is configured easily from four MG3710E units composed of one Primary and three Secondaries.

- Synchronization mode: Primary, Secondary, SG1 & 2
- Number of Secondaries: 1 to 3
- Secondary Position: 1 to 3
- Local Synchronization: On/Off
- IQ Phase Adjustment: -360 deg. to +360 deg., Resolution 0.01 deg.
- IQ Delay: -400 ns to +400 ns, Resolution 1 ps

- Common Setting
- Number of Secondaries: 3
- LO Sync: On

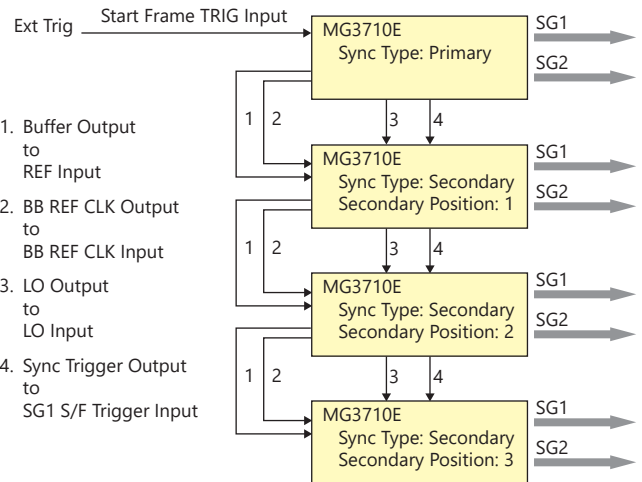

Note: MG3710E-017 is not required when synchronizing the local signal and baseband clock of SG1 (1stRF) and SG2 (2ndRF) installed in one MG3710E unit.

Operability

Easy Touch-panel Operation

Simply touching parts of the screen display with a finger fetches related function keys and numeric inputs, offering a fast and easy way of navigating through multilayer menus.

Modulation Screen (Mode)

Frequency Setting

Level Setting

Waveform Pattern Selection

Power Meter Function

BER Function

Operability

Two Signal Flowcharts

Pressing the on-screen  button toggles instantly between the Hardware Block Chart and the ARB Info screens.

The Hardware Block Chart is a quick-and-easy way to grasp the status of each block (ARB, AWGN, I/Q, Analog Mod, Pulse Mod, Local) at a glance.

The ARB Info screen displays more details about the ARB/AWGN block showing the baseband signal combine status of memory A + memory B, memory A + AWGN, etc.



ARB Info Screen



Hardware Block Chart Screen

Hardware Block Chart (Explanation)

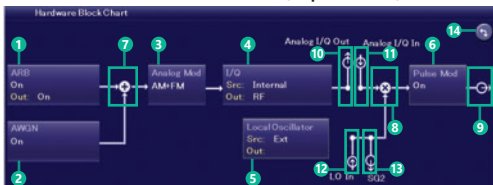

Hardware Block Chart Display Contents (Explanation)

No.	Display Example	Display	Description
1		ARB	ARB block
		On/Off	Indicates On/Off of ARB (function to generate modulated signals with arbitrary waveform patterns)
		Out	Indicates On/Off of the arbitrary waveform pattern output
2		AWGN	AWGN block
		On/Off	Indicates On/Off of AWGN addition
3		Analog Mod	Analog Modulation block
		AM/FM/PM	Indicates the analog modulation (AM/FM/PM) during modulation
4		I/Q Src: Internal/ Analog I/Q In	Indicates the I/Q signal source
		Out: RF/Analog I/Q Out	Indicates the output destination for baseband signals
5		Local Oscillator	Local Oscillator block
		Src: Int/Ext/Sync	Indicates the Local signal source
6		Pulse Mod	Pulse Modulation block
		On/Off	Indicates On/Off of Pulse modulation
7		—	Indicates that inputs from two function blocks of the left side and bottom side are combined and output to the function block of the right side
8		—	Indicates that the input Local signal from the bottom side is modulated with the input signal from the left side and output to the function block of the right side
9		—	Indicates the RF Output is On
10		Analog I/Q Out	Indicates the Analog I/Q signal is set to the external output
11		Analog I/Q In	Indicates the Analog I/Q signal is set to the external input
12		LO In (For SG1)	Indicates the SG1 Local signal source is set to Ext (input from the rear LO Input connector)
		SG1 (For SG2)	Indicates the SG2 Local signal source is set to Sync and the signal is input from SG1
13		SG2 (For SG1)	Indicates the SG1 Local signal external output setting is On and the signal is output to SG2. If SG2 is not installed, "LO Out" (output from the rear LO Output connector) is displayed
		LO Out (For SG2)	Indicates the Local signal external output setting (output from the rear LO Output connector) is On
14		—	Click to switch Hardware Block Chart and ARB Info display

Frequency Channel Table

Sometimes frequencies need setting by Channel No. The built-in frequency channel table where frequencies are set by channel number is ideal for this application. Once set and saved, these pre-settings can be read whenever needed.

Channel Table Setting

- Group: 1 to 19
- Start Channel: 0 to 20000
- End Channel: (Start Channel) to 20000
- Start Frequency
- Channel Spacing



Channel Table Setting Screen

Connection with External Equipment

Remote Control Interfaces

The MG3710E has GPIB, Ethernet and USB interfaces as standard, supporting the following functions:

- Control all functions, except power switch
- Read all status conditions and settings
- Interrupts and serial polls

While in the Local status, the interface is determined automatically by the communication start command from the external controller (PC). To change the interface, put the MG3710E into the Local status again by pressing the Local key on the front panel and then send a command via the desired interface.

GPIB: Conforms to IEEE488.1/IEEE488.2 standards

SH1, AH1, T6, L4, SR1, RL1, PP0, DC1, DT0, C0, E2

Ethernet: Conforms to VXI-11 protocol using TCP/IP Control programs

SH1, AH1, T6, L4, SR1, RL1, PP0, DC1, DT0, C0

USB: Conforms to USBTMC-USB488 protocols

SH1, AH1, T6, L4, SR1, RL1, PP0, DC1, DT0, C0n

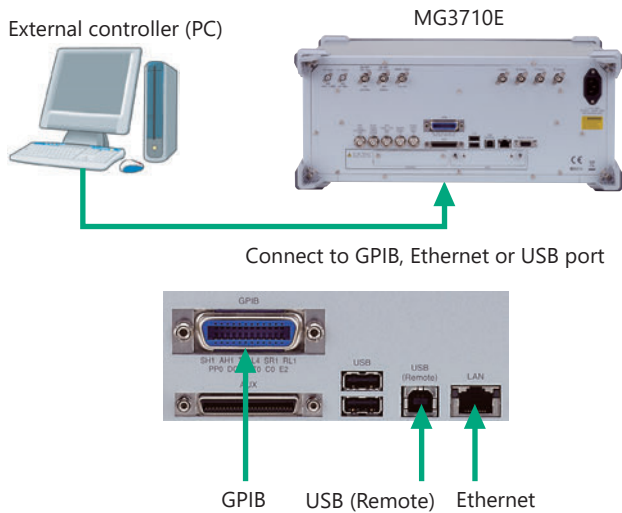

Remote control command is in common with the MG3710A and the MG3710E. Either select the SCPI mode command format defined by the SCPI Consortium, or select backwards compatible modes supporting earlier MG3700A, MS269xA, and MS2830A commands

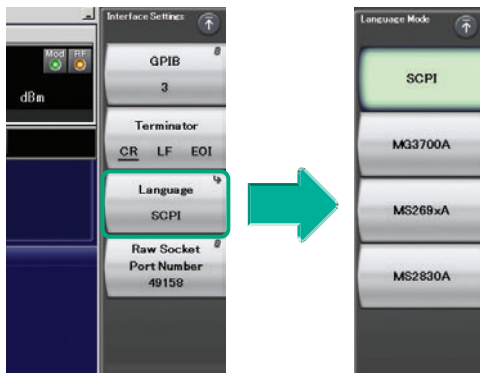

Command Format Setting Example

USB Connections

The two type-A USB2.0 connectors on the front and rear panels support keyboard, mouse and USB memory connections. Supported USB power sensors can be connected too.

USB Power Sensor [Sold separately]

Frequency Range: 600 MHz to 4 GHz	[MA24104A]*
350 MHz to 4 GHz	[MA24105A]
50 MHz to 6 GHz	[MA24106A]
10 MHz to 8 GHz	[MA24108A]
10 MHz to 18 GHz	[MA24118A]
10 MHz to 26 GHz	[MA24126A]

*: MA24104A has been discontinued. Replacement model is MA24105A.

Analog IQ Input/Output [MG3710E-018]

This option adds analog IQ input and output connectors to the front and rear panels, respectively. It only supports SG1 (1stRF).

Input: I Input, Q Input

Output: I Output, \bar{I} Output, Q Output, \bar{Q} Output,

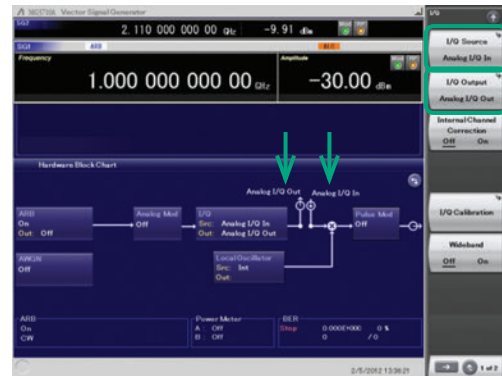

Analog IQ I/O Setting Screen

Analog IQ Input Adjustment

Setting Range: -100 mV to +100 mV

Analog IQ Output Adjustment

Output Voltage: 0.0 to 120.0%

In-phase DC offset: -2.5 V to +5.0 V

Differential DC offset: -50 mV to +50 mV

Connection with External Equipment

Trigger Input

Start and Frame triggers are installed as standard for outputting waveform patterns synchronized with externally input trigger signals.

Start Trigger Operation

At Start Trigger operation, after the waveform pattern is selected, output is started and continued by the rise timing of the first external trigger signal. Second and subsequent input external trigger signals are disabled. This is used when receiving a Start Trigger signal and reference frequency signal from the DUT at the MG3710E.

Frame Trigger Operation

At Frame Trigger operation, one frame of the waveform pattern is output at the rise timing of the external trigger signal. When frame output is finished, the trigger wait state is returned. This is used when receiving a Frame Trigger signal from the DUT at the MG3710E.

Frame Trigger supports three operations as follows:

(1) No Retrigger

Ignores triggers received during pattern output (default setting)

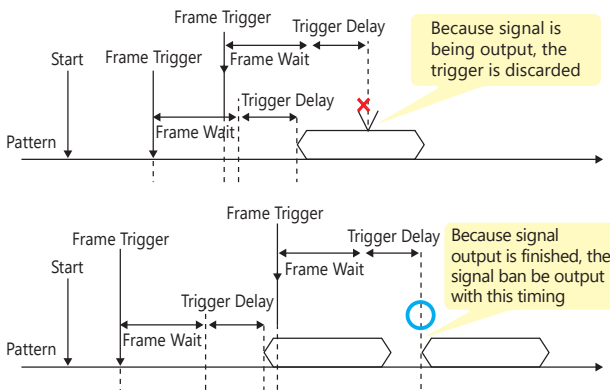

(2) Buffered Trig

Holds triggers received during pattern output until current pattern output completed and then outputs next frame

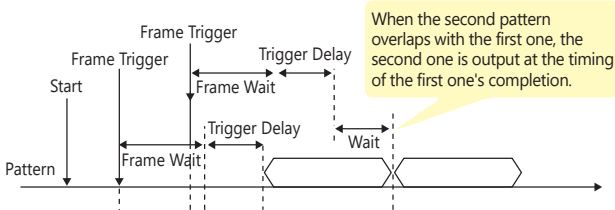

(3) Restart on Trig

Immediately restarts pattern when trigger received during pattern output

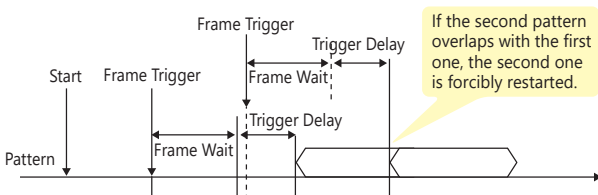

Marker Output Editing

Marker 1 Output [Standard]

Marker 2 & Marker 3 Output [Requires AUX Conversion Adapter J1539A]

When the Marker Setup function Edit Mode is Off, a marker signal combining the preset waveform pattern with marker information is output. When the Edit Mode is On, any marker for output can be set at the MG3710E screen. Up to 12 markers can be set for SG1/SG2, memory A/B and Marker 1 to 3.

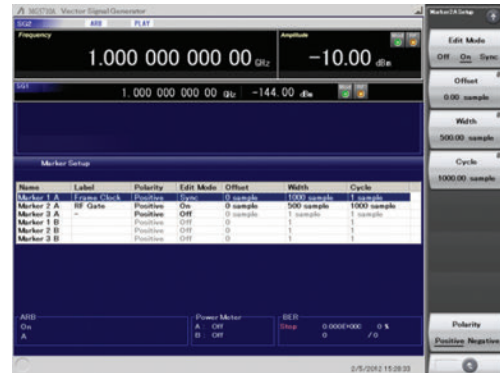

SG2 Marker Setup Screen
Memory A (1A/2A/3A), Memory B (1B/2B/3B)

There are three output connectors: Marker 1 Output on the rear panel and the AUX connector (Marker 2 Output and Marker 3 Output). The connector output signal layout can be selected freely.

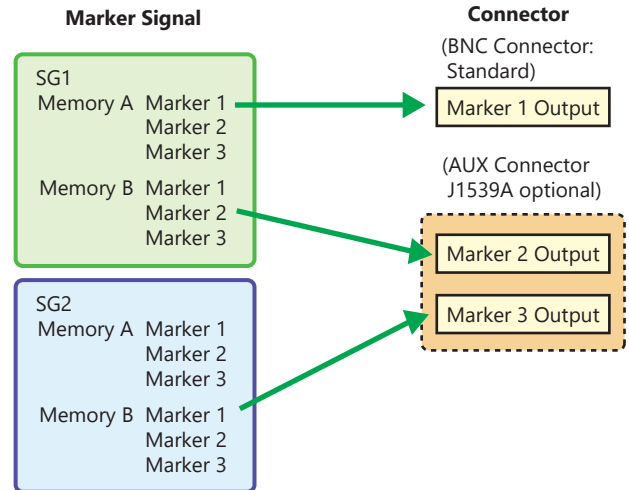

The defaults are as follows:

Marker Signal	Connector
SG1/Memory A/Marker 1	Marker 1 Output
SG1/Memory A/Marker 2	Marker 2 (@AUX)
SG1/Memory A/Marker 3	Marker 3 (@AUX)

IQproducer Waveform Generation Software

Waveform Generation Software (Separate license)

The IQproducer system provides an easy-to-use GUI for setting parameters according to each communications method.

The parameter setting results file can be saved as a file for easy recall later.

* For detail, refer to the IQproducer catalog.

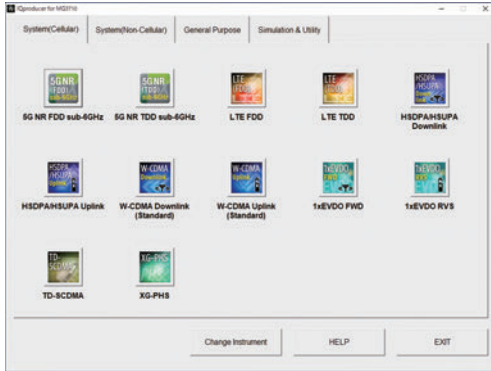

IQproducer Main Screen System (Cellular)

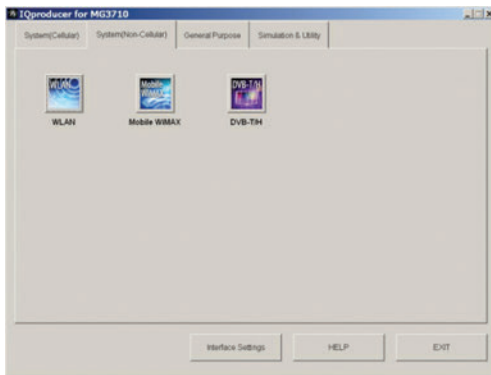

IQproducer Main Screen System (Non-Cellular)

If a license is not installed in the MG3710E, characters are displayed in red. Without a license, the IQproducer functions can still be tested but a license must be installed to actually output created waveform patterns.

IQproducer Options

HSDPA/HSUPA IQproducer	MX370101A
TDMA IQproducer	MX370102A
Multi-carrier IQproducer	MX370104A
DVB-T/H IQproducer	MX370106A
Fading IQproducer	MX370107A
LTE IQproducer	MX370108A
LTE-Advanced FDD Option	MX370108A-001*1
LTE TDD IQproducer	MX370110A
LTE-Advanced TDD Option	MX370110A-001*2
WLAN IQproducer	MX370111A
802.11ac (160 MHz) Option	MX370111A-002*3
TD-SCDMA IQproducer	MX370112A
5G NR TDD sub-6 GHz IQproducer	MX370113A
5G NR FDD sub-6 GHz IQproducer	MX370114A

*1: Requires MX370108A

*2: Requires MX370110A

*3: Requires MX370111A. Only for MG3710E/MG3710A

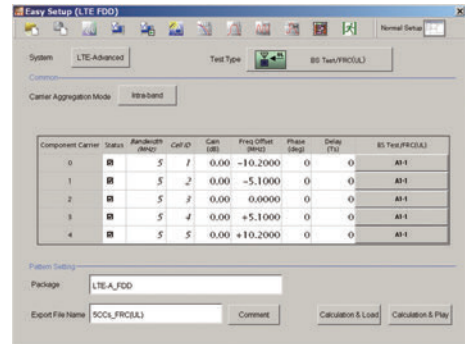

LTE IQproducer MX370108A/LTE-Advanced FDD Option MX370108A-001 LTE-Advanced Easy Setup Screen

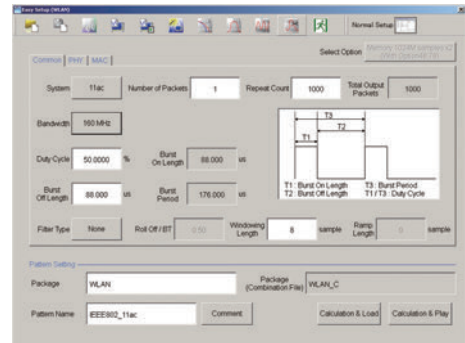

WLAN IQproducer MX370111A/802.11ac (160 MHz) Option MX370111A-002 WLAN IEEE 802.11ac Easy Setup Screen

IQproducer Waveform Generation Software

IQproducer

IQproducer supports the following functions free-of-charge as secondary waveform pattern creation functions.

- Convert
- AWGN
- Clipping
- CCDF/FFT/Time Domain
- Transfer & Setting/Transfer & Setting Wizard Combination File Edit

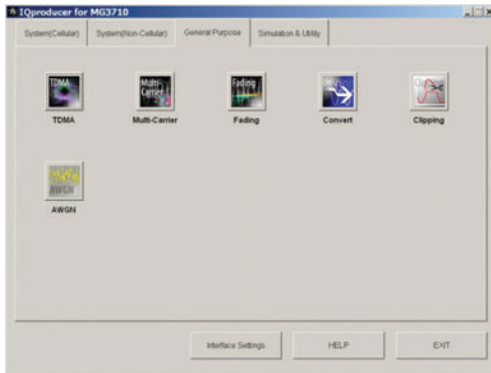

IQproducer Main Screen
General Purpose

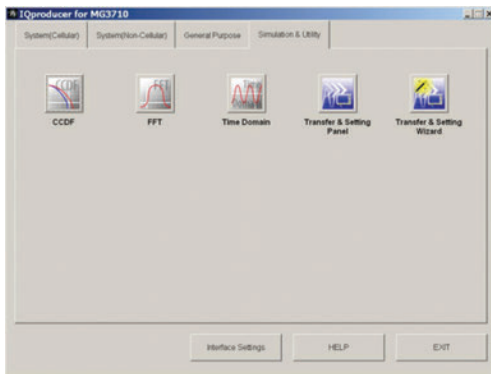

IQproducer Main Screen
Simulation & Utility

Operating Environment

PC	
OS	Windows 2000 Professional*1, Windows XP*2, Windows Vista*3, Windows 7 Enterprise (32-bit)*2, Windows 7 Professional (32-bit/64-bit)*2, Windows 10*4
CPU	Pentium III 1 GHz equivalent or faster
Memory	512 MB or more
Storage Device	5 GB or more free space on the drive where this software is to be installed.
Peripheral Device	
Display	Displays with a resolution of 1024 × 768 pixels are best viewed using a small font setting

*1: Does not support IQproducer Version 13.00 and later
 *2: Supports IQproducer Version 12.00 and later
 *3: Support IQproducer Version 12.00 to Version 16.01
 *4: Supports IQproducer Version 17.00 and later

Convert: Data Format Conversion

(1) ASCII-format IQ data created with other software, such as simulation software, can be converted to waveform pattern files used by the MG3710E.

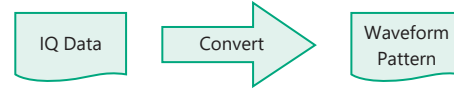

(2) Data files captured with Anritsu MS269xA Signal Analyzers and the capture function of the MS2830A Signal Analyzer can be converted to waveform pattern files used by the MG3710E.

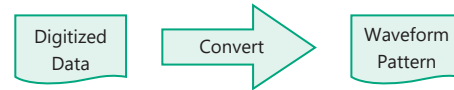

(3) Waveform patterns created by other Anritsu vector signal generators (MG3700A, MS269xA-020, MS2830A-020/021) can be converted to waveform pattern files used by the MG3710E and vice versa.

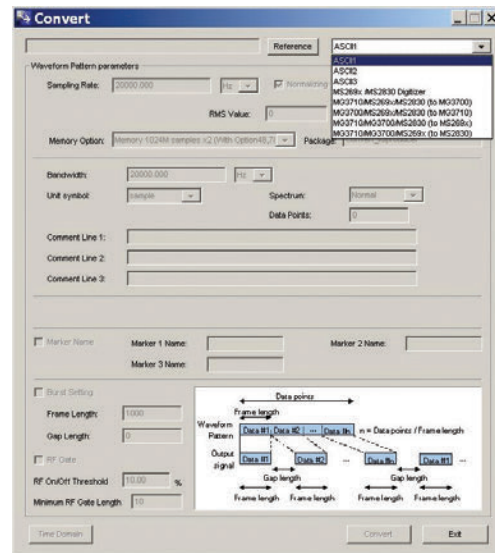
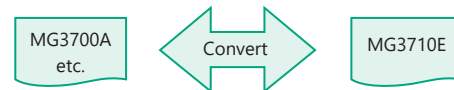

Convert Screen

IQproducer Waveform Generation Software

Clipping

This function clips each type of waveform pattern. The clipped waveform pattern is created by setting the filter, bandwidth, and repetition times.

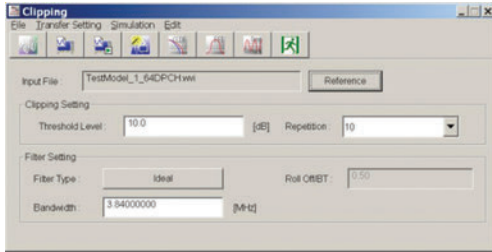

Clipping Screen

AWGN Waveform Generation

This function establishes the sampling rate and bandwidth, allowing any AWGN waveform pattern to be created. In addition, when the first combined waveform pattern (Wanted Signal) is selected, the Wanted Signal bandwidth and sampling rate are set automatically. The resulting AWGN waveform pattern can be combined with an existing waveform pattern, which is useful for base-station dynamic-range measurements.

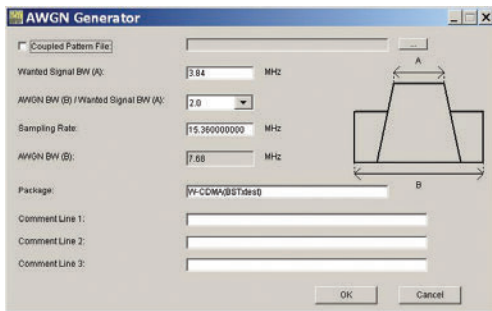

AWGN Screen

Main setting parameters

- (1) Wanted Signal Bandwidth:
 - Setting range: 0.0010 MHz to 120.0000 MHz
- (2) AWGN BW (B)/Wanted Signal BW (A):
 - Magnification of AWGN to Wanted Signal
 - Setting range: 1.0, 1.5, 2.0, 2.5
- (3) Sampling Rate:
 - Setting range: 0.0200 MHz to 160.0000 MHz
 - Note: Same value as wanted signal
- (4) AWGN Bandwidth (B):
 - Calculated automatically from (1) and (2) under following items:
 - Limit range: 0.001 MHz to 20.000 MHz: Sampling rate/2 max.
 - 20.001 MHz to 120.000 MHz: Sampling rate max.

CCDF/FFT/Time Domain Graphical Displays

CCDF (Complementary Cumulative Distribution Function)

Up to 8 created waveform patterns are read and displayed simultaneously as CCDF graphs.

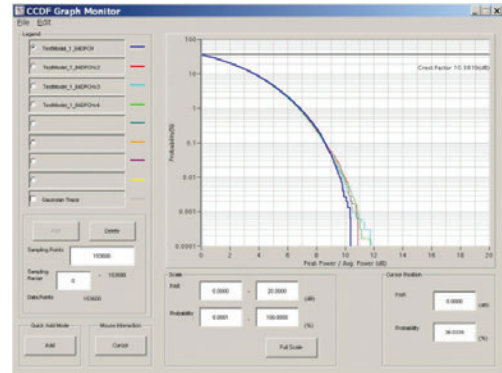

CCDF Screen

FFT (Fast Fourier Transform)

Up to 4 created waveform patterns are read, FFT-processed and displayed simultaneously as FFT graphs.

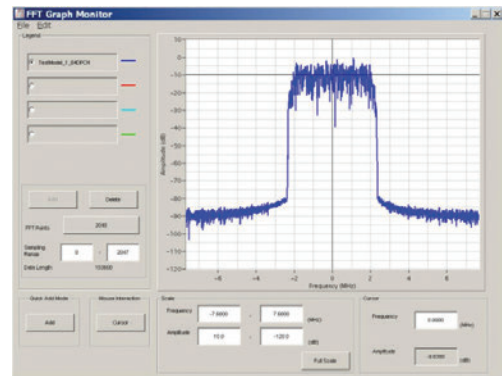

FFT Screen

Time Domain

Up to 4 created waveform patterns are read, and displayed simultaneously as Time Domain graphs.

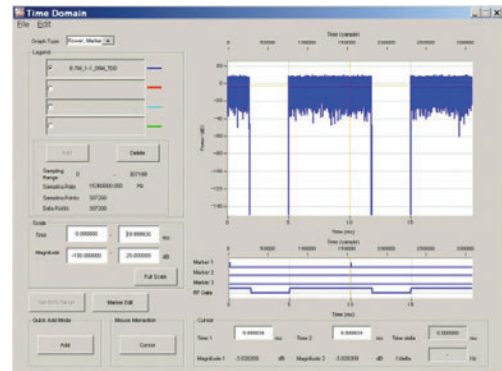

Time Domain Screen

IQproducer Waveform Generation Software

Transfer and Settings: Data Transfer

Waveform pattern files, graphics files, firmware version upgrades, etc., can be moved between a LAN-connected PC and MG3710E. When several MG3710E units are connected via LAN, waveform patterns can be transferred by a single operation, helping cut work times. Moreover, waveform pattern files saved on the storage device of a remote-controlled MG3710E can be opened in arbitrary waveform memory to select and output the waveform pattern.

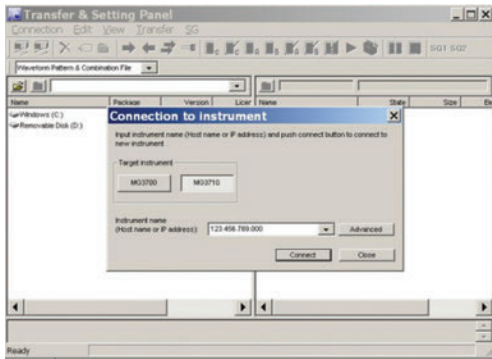

Transfer & Setting Screen

Combination File Edit Function

The Combination File Edit function is a Transfer & Setting Edit function. The following parameters are set automatically by selecting the Combination File:

- Waveform pattern
- Repetition times
- Interference waveform pattern (memory B)
- Frequency offset used when memory A and B added
- Level ratio (This value represents CN when memory A and B are added, or the relative level between elements when using only memory A.)

Using Combination Files that place the wanted and interference waveforms in separate memories makes it easy to measure receiver characteristics.

Combination files can also be used to create waveform sequences. Receive signal status transitions can be verified by using Sequence Mode Combination files defining switching and repetition times for multiple waveform patterns. Required waveform patterns and combination are saved to memory. Moreover, external triggers can be used to repeat each waveform pattern any number of times.

- Efficient memory use
- Validate response status transitions
- Manual control of sequences

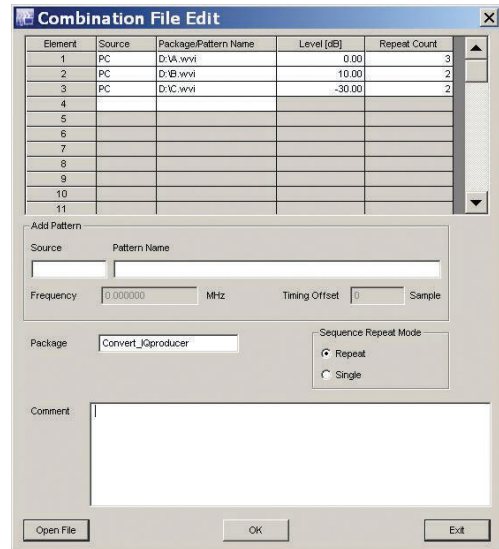

Combination File Edit Screen

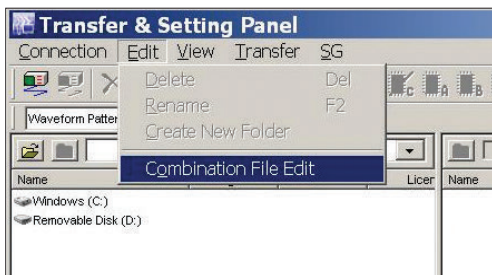

Transfer & Setting Screen
Combination File Edit Selection

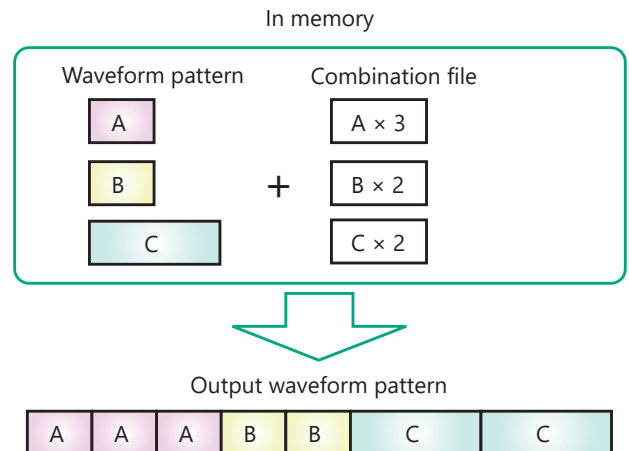

Options (Hardware)

Hardware (Common)

Rubidium Reference Oscillator **MG3710E-001**
Rubidium Reference Oscillator Retrofit **MG3710E-101**

Installs 10 MHz reference crystal oscillator with excellent frequency stability startup characteristics of $\pm 1 \times 10^{-9}$ at 7.5 minutes after power-on.

Aging Rate: $\pm 1 \times 10^{-10}$ /month
 Temperature stability: $\pm 2 \times 10^{-9}$ (5°C to 45°C)
 Start-up characteristics*: $\pm 1 \times 10^{-9}$ (7.5 minutes after power-on)

*: at 23°C, compared to frequency after 24 h warm-up

High Stability Reference Oscillator **MG3710E-002**
High Stability Reference Oscillator Retrofit **MG3710E-102**

Installs 10 MHz reference oscillator with better frequency stability as follows:.

Aging Rate: $\pm 1 \times 10^{-7}$ /year, $\pm 1 \times 10^{-8}$ /day
 Temperature stability: $\pm 2 \times 10^{-8}$ (5°C to 45°C)
 Start-up characteristics*: $\pm 5 \times 10^{-7}$ (2 minutes after power-on)
 $\pm 5 \times 10^{-8}$ (5 minutes after power-on)

*: at 23°C, compared to frequency after 24 h warm-up

2ndary HDD **MG3710E-011**
2ndary HDD Retrofit **MG3710E-111**

This removable storage device is installed in the HDD Option Slot of the MG3710E main unit to expand the user data storage space.

It does not have the Windows OS installed. The MG3710E ships with it installed. Only one expansion HDD can be installed in the MG3710E. It is useful when taking the instrument for calibration but the security of saved user data, such as measurement results, must be protected.

Removable HDD, Win10 **MG3710E-014**
Removable HDD, Win10 Retrofit **MG3710E-114**
Removable HDD, Win10 Retrofit **MG3710E-214**

This additional user-changeable storage device contains the same Windows OS and programs as the factory installed system storage device. It supports a Windows 10 install for one specific MG3710E and is for use during service repair and calibration.

Universal Input/Output **MG3710E-017**
Universal Input/Output Retrofit **MG3710E-117**

Installs following signal I/O connectors on rear panel of main unit. Required for local frequency sync for MIMO applications

Baseband Reference Clock Input/Output
 Sweep Output (only supports SG1)
 Local Signal Input/Output

* Also provides AUX Conversion Adapter J1539A for MG3710E-017/117 to use rear-panel AUX connector

BER Test Function **MG3710E-021**
BER Test Function Retrofit **MG3710E-121**

Installs BER measurement function

* Also provides AUX Conversion Adapter J1539A for MG3710E-021/121 to use rear-panel AUX connector

Hardware (For 1stRF)

1stRF 100 kHz to 2.7 GHz **MG3710E-032**
1stRF 100 kHz to 4 GHz **MG3710E-034**
1stRF 100 kHz to 6 GHz **MG3710E-036**

Selects 1stRF frequency range
 The frequency range cannot be changed after installation.

Analog IQ Input/Output **MG3710E-018**
Analog IQ Input/Output Retrofit **MG3710E-118**

Installs analog I/Q input connector on front panel and output connector on rear panel of main unit

High Power Extension for 1stRF **MG3710E-041**
High Power Extension for 1stRF Retrofit **MG3710E-141**

Extends signal output setting range upper limit
 MG3710E-041/141 installed and MG3710E-043/143 not installed
 Level setting range: Hi limit +30 dBm (Standard +17 dBm)
 MG3710E-041/141 not installed and MG3710E-043/143 not installed
 Level setting range: Hi limit +25 dBm (Standard +17 dBm)

Low Power Extension for 1stRF **MG3710E-042**
Low Power Extension for 1stRF Retrofit **MG3710E-142**

Extends signal output setting range lower limit
 Level setting range: Lo limit -144 dBm (Standard -110 dBm)

Reverse Power Protection for 1stRF **MG3710E-043**
Reverse Power Protection for 1stRF Retrofit **MG3710E-143**

Protects signal output connector against reverse input power
 (Standard: 2 W nom.)
 Max reverse input: 20 W (nom.) (1 MHz < f ≤ 2 GHz)
 10 W (nom.) (2 GHz < f ≤ 6 GHz)

ARB Memory Upgrade 256 Msample for 1stRF **MG3710E-045**
ARB Memory Upgrade 256 Msample for 1stRF Retrofit **MG3710E-145**

Upgrades ARB size to 256 Msamples (1 GB)
 (standard is 64 Msamples/256 MB)
 With MG3710E-048/148 not installed, installs 1 × 256 Msamples
 With MG3710E-048/148 installed, installs 2 × 256 Msamples

ARB Memory Upgrade 1024 Msample for 1stRF **MG3710E-046**
ARB Memory Upgrade 1024 Msample for 1stRF Retrofit **MG3710E-146**

Upgrades ARB size to 1024 Msamples (4 GB)
 (standard is 64 Msamples/256 MB)
 With MG3710E-048/148 not installed, installs 1 × 1024 Msamples
 With MG3710E-048/148 installed, installs 2 × 1024 Msamples

Combination of Baseband Signal for 1stRF **MG3710E-048**
Combination of Baseband Signal for 1stRF Retrofit **MG3710E-148**

Two internal waveform memories. Selects two waveform patterns per one RF output for setting mutual frequency offset, level offset, delay time, etc., to output 2 signals from 1 RF connector

AWGN for 1stRF **MG3710E-049**
AWGN for 1stRF Retrofit **MG3710E-149**

Internal AWGN addition function. Adjusts AWGN bandwidth range setting as follows for selected waveform pattern:

Band limit: waveform pattern sampling rate × 0.2
 to waveform pattern sampling rate × 0.8 .
 CN: ≤40 dB

Additional Analog Modulation Input for 1st RF **MG3710E-050**
Additional Analog Modulation Input for 1st RF Retrofit **MG3710E-150**

Adds additional analog modulation inputs function for 1stRF. Extends to two internal modulation sources (AM/FM/ΦM), and one external modulation source supporting simultaneous two-signal modulation. Installs external signal input connector on rear panel of main unit.

Options (Hardware)

Hardware (For 2ndRF)

2ndRF 100 kHz to 2.7 GHz	MG3710E-062
2ndRF 100 kHz to 4 GHz	MG3710E-064
2ndRF 100 kHz to 6 GHz	MG3710E-066
2ndRF 100 kHz to 2.7 GHz Retrofit	MG3710E-162
2ndRF 100 kHz to 4 GHz Retrofit	MG3710E-164
2ndRF 100 kHz to 6 GHz Retrofit	MG3710E-166

Selects 2ndRF frequency range

The frequency range cannot be changed after installation.

Can only be retrofitted when 2ndRF not installed.

High Power Extension for 2ndRF	MG3710E-071
High Power Extension for 2ndRF Retrofit	MG3710E-171

Extends signal output setting range upper limit

MG3710E-071/171 installed and MG3710E-073/173 not installed

Level setting range: Hi limit +30 dBm (Standard +17 dBm)

MG3710E-071/171 not installed and MG3710E-073/173 not installed

Level setting range: Hi limit +25 dBm (Standard +17 dBm)

Low Power Extension for 2ndRF	MG3710E-072
Low Power Extension for 2ndRF Retrofit	MG3710E-172

Extends signal output setting range lower limit

Level setting range: Lo limit -144 dBm (Standard -110 dBm)

Reverse Power Protection for 2ndRF	MG3710E-073
Reverse Power Protection for 2ndRF Retrofit	MG3710E-173

Protects signal output connector against reverse input power

(Standard: 2 W nom.)

Max reverse input: 20 W (nom.) (1 MHz < f ≤ 2 GHz),

10 W (nom.) (2 GHz < f ≤ 6 GHz)

ARB Memory Upgrade 256 Msample for 2ndRF	MG3710E-075
ARB Memory Upgrade 256 Msample for 2ndRF Retrofit	MG3710E-175

Upgrades ARB size to 256 Msamples (1 GB)

(standard is 64 Msamples/256 MB)

With MG3710E-078/178 not installed, installs 1 × 256 Msamples

With MG3710E-078/178 installed, installs 2 × 256 Msamples

ARB Memory Upgrade 1024 Msample for 2ndRF	MG3710E-076
ARB Memory Upgrade 1024 Msample for 2ndRF Retrofit	MG3710E-176

Upgrades ARB size to 1024 Msamples (4 GB)

(standard is 64 Msamples/256 MB)

With MG3710E-078/178 not installed, installs 1 × 1024 Msamples

With MG3710E-078/178 installed, installs 2 × 1024 Msamples

Combination of Baseband Signal for 2ndRF	MG3710E-078
Combination of Baseband Signal for 2ndRF Retrofit	MG3710E-178

Two internal waveform memories. Selects two waveform patterns per one RF output for setting mutual frequency offset, level offset, delay time, etc., to output 2 signals from 1 RF connector

AWGN for 2ndRF	MG3710E-079
AWGN for 2ndRF Retrofit	MG3710E-179

Internal AWGN addition function. Adjusts AWGN bandwidth range setting as follows for selected waveform pattern:

Band limit: waveform pattern sampling rate × 0.2
to waveform pattern sampling rate × 0.8

CN: ≤40 dB

Additional Analog Modulation Input for 2nd RF	MG3710E-080
Additional Analog Modulation Input for 2nd RF Retrofit	MG3710E-180

Adds additional analog modulation inputs function for 2ndRF. Extends to two internal modulation sources (AM/FM/ΦM), and one external modulation source supporting simultaneous two-signal modulation. Installs external signal input connector on rear panel of main unit.

Options (Software)

Waveform Patterns & License

DFS Radar Pattern

MX370073B

Sets pulse signals for testing 5-GHz band WLAN DFS functions. The MX370073B supports the waveform patterns for the FCC and Japan MIC test specifications. Pulse signals are output simply by selecting the pattern.

DFS (ETSI) Waveform Pattern

MX370075A

Sets pulse signals for testing 5-GHz band WLAN DFS functions. The MX370075A supports the waveform patterns for the ETSI specifications. Pulse signals are output simply by selecting the pattern.

What is DFS?

5-GHz band wireless LAN devices like meteorological radar, marine radar, etc., have a Dynamic Frequency Selection (DFS) function for switching to an empty channel when detecting a radio wave. At testing, pulse, chirping and hopping signals like those used by radar are output from the SG to the WLAN equipment to check that it does not output signals in that channel.

ISDB-Tmm Waveform Pattern

MX370084A

Archive of ARIB STD-B46 waveform patterns. Supports MER and spectrum evaluation of Tx characteristics tests and sensitivity/simple BER tests at Rx characteristics tests.

Interference Waveform Pattern for LTE Receiver Test

MX371054A

Set of main interference waveform patterns for LTE UE Rx sensitivity and throughput tests. Interference signals are output simply by selecting the pattern.

Standard: 3GPP TS 36.521-1V16

Test items: Adjacent Channel Selectivity, In-band blocking, Wideband intermodulation

Interference Waveform Pattern for 5G NR Receiver Test

MX371055A

Main modulated interference signals for 5G UE receiver sensitivity and throughput tests. Interference signals are output simply by selecting the pattern.

Standard: 3GPP TS 38.521-1V17

Test items: Adjacent Channel Selectivity, In-band blocking, Wideband intermodulation

IQproducer License

IQproducer is PC application software for generating waveform patterns. The parameters are set using IQproducer and the waveform pattern is created to output the signal by selection at the MG3710E. This one software application includes all the following systems. Since it runs on any PC, the supported functions and parameter range can be verified before purchase.

When outputting a waveform pattern from the MG3710E, no signal is output unless a license for that system is installed in the main unit.

* Read the "IQproducer catalog" for details.

HSDPA/HSUPA IQproducer

MX370101A

Sets parameters according to HSDPA/HSUPA (Uplink and Downlink) specifications, and generates HSDPA/HSUPA waveform patterns including Fixed Reference Channel (3GPP TS 25.101 Annex A.7).

TDMA IQproducer

MX370102A

Sets required parameters for TDMA waveform patterns and generates various waveform patterns. Setting parameters include Modulation, Frame, Slot, Data, Filter, etc. Supports wide application range including public wireless.

Multi-carrier IQproducer

MX370104A

Generates multi-carrier waveform patterns combination files using MG3710E Baseband Signal Combine function (requires MG3710E-048/078).

DVB-T/H IQproducer

MX370106A

Sets parameters according to ETSI EN 300 744 V1.5.1 (2004-11) physical layer standard and generates DVB-T/H waveform patterns. Generated waveform patterns can be used for device TRx characteristics evaluation tests (Error Correction, BER graphics).

Fading IQproducer

MX370107A

Performs IQ channel fading processing, correlation matrix calculation, AWGN combination. Input data file created by selecting waveform pattern file created with other IQproducer software, and IQ data (ASCII) created with other general-purpose simulation tools.

LTE IQproducer

MX370108A

Generates wanted waveform patterns with parameters modified according to 3GPP TS 36.211, TS 36.212, TS 36.213 LTE FDD specifications.

LTE-Advanced FDD Option

MX370108A-001

Installing in the MX370108A supports simple generation of carrier aggregation signals added by 3GPP Rel. 10. Additionally, clustered SC-FDMA signals can be generated at Uplink.

*: Requires MX370108A

LTE TDD IQproducer

MX370110A

Generates wanted waveform patterns with parameters modified according to 3GPP TS 36.211, TS 36.212, TS 36.213 LTE TDD specifications.

LTE-Advanced TDD Option

MX370110A-001

Installing in the MX370110A supports simple generation of carrier aggregation signals added by 3GPP Rel. 10. Additionally, clustered SC-FDMA signals can be generated at Uplink.

*: Requires MX370110A

Options (Software)

WLAN IQproducer

Generates waveform patterns for IEEE Std 802.11-2007 and IEEE Std 802.11n-2009 IEEE 802.11a/b/g/j/n/p specifications.

802.11ac (160 MHz) Option

Installing in the MX370111A supports waveform patterns generation compliant with IEEE 802.11ac specifications.

*: Requires MX370111A. Only for MG3710E.

MX370111A

MX370111A-002

TD-SCDMA IQproducer

Generates wanted waveform patterns with parameters modified according to TD-SCDMA specifications standardized by TRx characteristics evaluation tests (excluding performance tests) for 3GPP TS 25.221, TS 25.222, TS 25.223, TS 25.105, TS 25.142

5G NR TDD sub-6 GHz IQproducer

5G NR FDD sub-6 GHz IQproducer

Generates 3GPP TS 38.211, TS 38.212, and TS 38.213 defined waveform patterns in compliance with the 5G NR sub-6 GHz specifications.

MX370112A

MX370113A

MX370114A

Vector Signal Generator series

Supported LTE-Advanced Carrier Aggregation Modes

Vector Signal Generator Series	Vector Signal Generator		Vector Signal Generator Option for Signal Analyzer	
	MG3710E/MG3710A*1	MG3700A*1	MS2690A series Option 020*2	MS2830A Option 020/021*2
Carrier Aggregation Mode				
Intra-band contiguous Carrier Aggregation, Intra-band non-contiguous Carrier Aggregation	✓ (1 unit)	✓ (1 unit)	✓ (1 unit)	✓ (1 unit)
Inter-band non-contiguous Carrier Aggregation	✓ (2 RF 1 unit*3, or 1 RF 2 units)	✓ (2 units)	✓ (2 units)	✓ (2 units)

*1: LTE IQproducer MX370108A and LTE-Advanced FDD Option MX370108A-001 installed.

LTE TDD IQproducer MX370110A and LTE-Advanced TDD Option MX370110A-001 installed.

*2: LTE IQproducer MX269908A and LTE-Advanced FDD Option MX269908A-001 installed.

LTE TDD IQproducer MX269910A and LTE-Advanced TDD Option MX269910A-001 installed.

*3: MG3710E-062 (2.7 GHz)/064 (4 GHz)/066 (6 GHz) 2ndRF Option installed.

Vector Signal Generator series

Supported WLAN IEEE 802.11ac Signal Bandwidth

Vector Signal Generator Series	Vector Signal Generator		Vector Signal Generator Option for Signal Analyzer	
	MG3710E/MG3710A*1	MG3700A*2	MS2690A series Option 020*3	MS2830A Option 020/021*3
IEEE 802.11ac Signal Bandwidth				
20 MHz/40 MHz/80 MHz	✓ (1 unit)	✓ (1 unit)	✓ (1 unit)	✓ (1 unit)
160 MHz	✓ (1 unit)	—	—	—
80 MHz + 80 MHz (non-contiguous)	✓ (2 RF 1 unit*4, or 1 RF 2 units)	✓ (2 units)	✓ (2 units)	✓ (2 units)

*1: WLAN IQproducer MX370111A and 802.11ac (160 MHz) Option MX370111A-002 installed.

*2: WLAN IQproducer MX370111A and 802.11ac (80 MHz) Option MX370111A-001 installed.

*3: WLAN IQproducer MX269911A and 802.11ac (80 MHz) Option MX269911A-001 installed.

*4: MG3710E-062 (2.7 GHz)/064 (4 GHz)/066 (6 GHz) 2ndRF Option installed.

Rx Characteristics Evaluation Tests for Digital Narrowband Communications, Public Safety, etc.

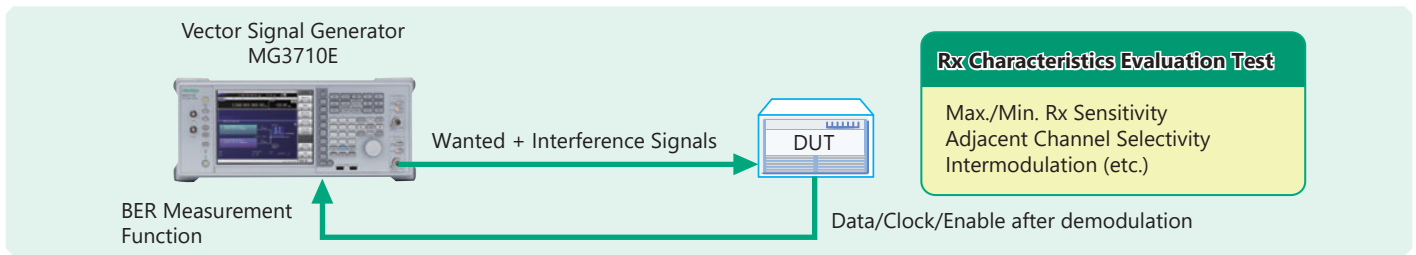

Supports SSB Phase Noise Performance -140 dBc/Hz nom. (@100 MHz)

Phase noise performance affects measurement results at narrow bandwidths of several kHz. In particular, high phase-noise performance is required for interference waveforms.

Improved SSB phase noise supports wider specification margins and stable measurements to improve yields.

- <-140 dBc/Hz (nom.) @100 MHz, 20-kHz offset, CW
- <-131 dBc/Hz (typ.) @1 GHz, 20-kHz offset, CW
- <-125 dBc/Hz (typ.) @2 GHz, 20-kHz offset, CW



TDMA IQproducer [MX370102A] Supports Following Modulation Methods

- BPSK, DBPSK, PI/2DBPSK, QPSK, DQPSK, PI/4DQPSK, 8PSK, D8PSK, 16QAM, 32QAM, 256QAM, ASK, 2FSK, 4FSK,

The TDMA IQproducer PC software generates waveform patterns with any frame format or filter settings. One software package supports various narrowband digital communications.

Two modulation signals can be output from one RF output using the baseband signal combine function (MG3710E-048/078). The level ratio (CN = 80 dB) and the frequency offset (± 80 MHz max.) can be set as well. Usually, tests using two modulation signals, such as adjacent channel selectivity (ACS) and intermodulation characteristics (IM) require two signal generators as well as a software license for each signal generator.

The MG3710E has two waveform memories for each RF output for setting and outputting different waveform data. One RF outputs the combined wanted + interference signals for a baseband bandwidth. Not only are equipment costs greatly reduced, but fewer external equipment, such as couplers, level adjusters, etc., as well as less setup time are required.

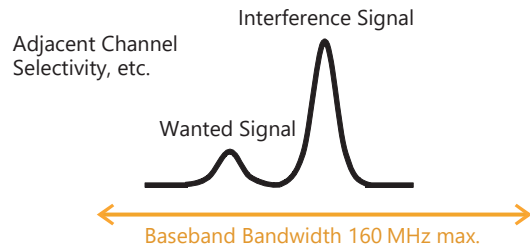

Supports BER Measurement Function [MG3710E-021]

The BER can be measured using the DUT-demodulated Data/Clock/Enable. The measurement results are displayed on the MG3710E screen.

Input Bit Rate: 100 bps to 40 Mbps

Rx Sensitivity Tests for Multi-system Mobile Terminals, etc.

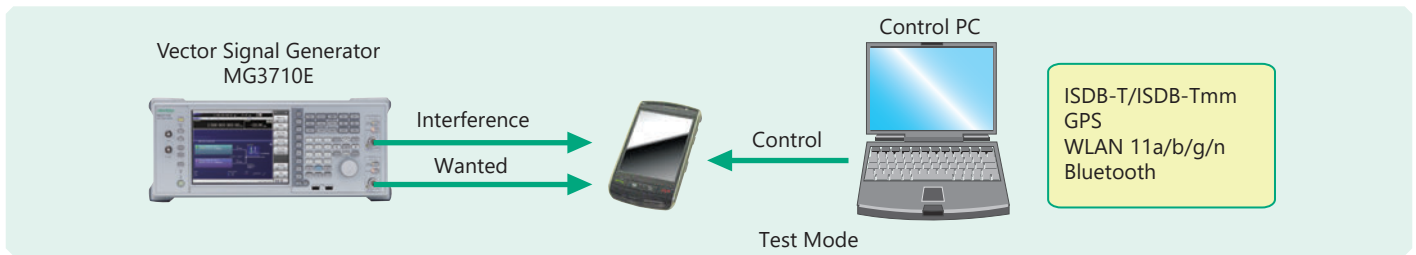

The MG3710E can save up to 1024 Msamples (4 GB) per RF. Memory size is one of the most important specifications for an arbitrary waveform signal generator. Small memory cannot save multiple waveform data and requires time-wasting reloading and measurement to output different signals each time.

With large waveform memory

- Switch loaded waveform data instantaneously
- Load multiple test waveforms
→ Reduce number of reloads → Cuts times



License-free Pre-installed Waveform Patterns

WLAN 11a/b/g, Bluetooth, GPS, etc.

The following waveform patterns are available as options.

ISDB-Tmm (MX370084A)

Optional waveform generation tools are also available (license separately sold):

- DVB-T/H (MX370106A)
- WLAN 11a/b/g/n/j/p (MX370111A)
- WLAN 11ac (MX370111A-002)

Two RF outputs can be installed as an option.

Additionally, two RF output models with different frequencies can be installed. For example, if WLAN 11b/g are the wanted waveforms, mobile signals for LTE FDD, LTE TDD, W-CDMA, GSM, etc., are considered interference signals. Generally, these tests have high hardware and software costs because two separate signal generators are required. Using the MG3710E, the total investment costs for interference tests under simulated service conditions, such as WLAN + LTE FDD, or ISDB-T + W-CDMA, are reduced by selecting models with different frequencies for the 1stRF and 2ndRF outputs.

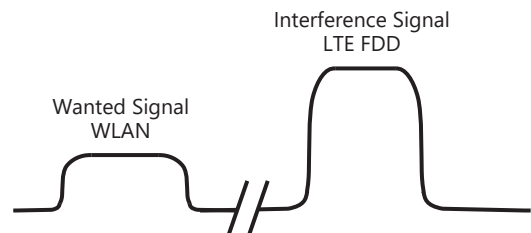

Wanted and Interference Waveforms for Rx Characteristics Evaluations of Cellular Base Station, etc.

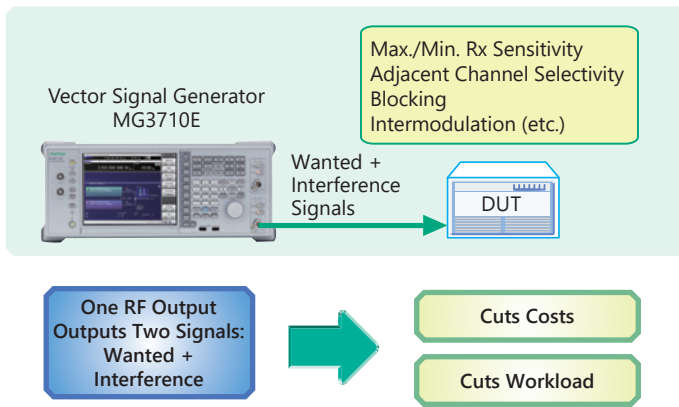

Two modulation signals can be output from one RF output using the baseband signal combine function (MG3710E-048/078). The level ratio (CN = 80 dB) and the frequency offset (± 80 MHz max.) can be set as well. Tests using two modulation signals, such as Adjacent Channel Selectivity (ACS), Blocking, and Intermodulation (IM), etc., require two separate signal generators and a license for each, greatly increasing equipment costs and setting work loads. The MG3710E has two waveform memories for each RF output for setting and outputting different waveform data. One RF outputs the combined wanted + interference signals for a baseband bandwidth. Not only are equipment costs greatly reduced, but fewer external equipment, such as couplers, level adjusters, etc., as well as less setup time are required. In comparison to previous Anritsu instruments, frequency offsets can be set for both memory A and B, and the sampling rate for memory A and B can be adjusted automatically.

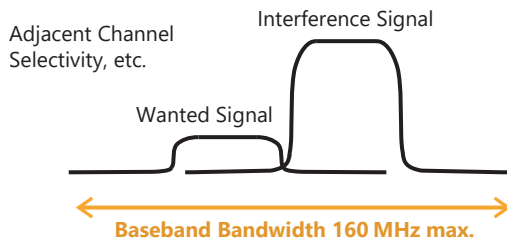

Installing the BER measurement (MG3710E-021) and AWGN Generation (MG3710E-049/079) options supports the extra functions required for Rx tests of each type of communications system.

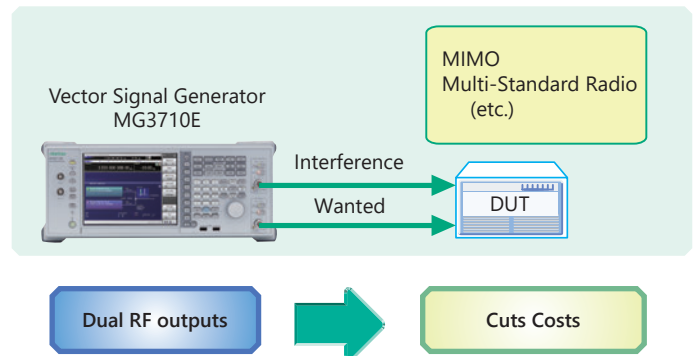

Two RF outputs can be installed as an option. A different frequency, level and waveform pattern/CW can be set for each RF output, which is ideal for Rx tests using two signals for frequency offset that cannot be set using the baseband combine function. For example, sometimes at MSR, multiple signals must be output simultaneously in the 200-MHz band, requiring two RF outputs.

Multi-Standard Radio Rx Characteristics Tests

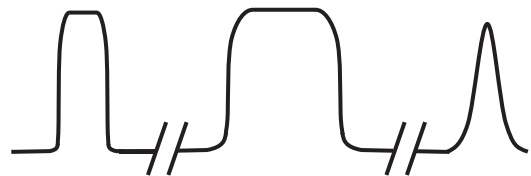

Installing two RF units in one MG3710E unit makes it easy to synchronize between channels. And adding the Universal Input/Output option (MG3710E-017) supports Local Signal I/O for synchronizing with other MG3710E units.

The IQproducer waveform generation software can be used with one license when two RF units are installed. For example, for LTE 2x2 MIMO tests, LTE IQproducer can generate two patterns for the Tx antenna signals and Fading IQproducer can generate two patterns with spatial multiplexing for the Rx antennas. Previously, using two signal generators required two separate licenses for LTE and fading, but now only one license is required to use IQproducer with the MG3710E with two RF units installed, helping cut software costs too.

Options Configuration Guide

The following table shows the recommended option combinations.

Type	Option No	Retrofit	Name	032	034	036	018	041	042	043	045	046	048	049	050	062	064	066	071	072	073	075	076	078	079	080	001	002	011	014	017	021	182		
1stRF	MG3710E-032		1stRF 100 kHz to 2.7 GHz		*1	*1																													
1stRF	MG3710E-034		1stRF 100 kHz to 4 GHz		*1																														
1stRF	MG3710E-036		1stRF 100 kHz to 6 GHz			*1																													
1stRF	MG3710E-018	118	Analog IQ Input/Output																																
1stRF	MG3710E-041	141	High Power Extension for 1stRF																																
1stRF	MG3710E-042	142	Low Power Extension for 1stRF																																
1stRF	MG3710E-043	143	Reverse Power Protection for 1stRF																																
1stRF	MG3710E-045	145	ARB Memory Upgrade 256 Msample for 1stRF									*3																							
1stRF	MG3710E-046	146	ARB Memory Upgrade 1024 Msample for 1stRF								*3																								
1stRF	MG3710E-048	148	Combination of Baseband Signal for 1stRF																																
1stRF	MG3710E-049	149	AWGN for 1stRF																																
1stRF	MG3710E-050	150	Additional Analog Modulation Input for 1stRF																																
2ndRF	MG3710E-062	162	2ndRF 100 kHz to 2.7 GHz														*2	*2																	
2ndRF	MG3710E-064	164	2ndRF 100 kHz to 4 GHz														*2	*2																	
2ndRF	MG3710E-066	166	2ndRF 100 kHz to 6 GHz														*2	*2																	
2ndRF	MG3710E-071	171	High Power Extension for 2ndRF																																
2ndRF	MG3710E-072	172	Low Power Extension for 2ndRF																																
2ndRF	MG3710E-073	173	Reverse Power Protection for 2ndRF																																
2ndRF	MG3710E-075	175	ARB Memory Upgrade 256 Msample for 2ndRF																																
2ndRF	MG3710E-076	176	ARB Memory Upgrade 1024 Msample for 2ndRF																																
2ndRF	MG3710E-078	178	Combination of Baseband Signal for 2ndRF																																
2ndRF	MG3710E-079	179	AWGN for 2ndRF																																
2ndRF	MG3710E-080	180	Additional Analog Modulation Input for 2ndRF																																
Common	MG3710E-001	101	Rubidium Reference Oscillator																																
Common	MG3710E-002	102	High Stability Reference Oscillator																																
Common	MG3710E-011	111	2ndary HDD																																
Common	MG3710E-014	114*4	Removable HDD, Win10																																
Common	MG3710E-017	117	Universal Input/Output																																
Common	MG3710E-021	121	BER Test Function																																
Common	MG3710E-182	182	CPU/Windows10 Upgrade Retrofit*5																																

*1: Only one of 2.7 GHz, 4 GHz, and 6 GHz options. Install any one 1stRF option. Retrofitting one of these options disables previously installed option.

*2: Only one of 2.7 GHz, 4 GHz, and 6 GHz options. Retrofitting one of these options disables previously installed option. Install any one 2ndRF option.
Can be retrofitted only when 2ndRF not installed.

*3: Select any one. Selected memory size enabled and all others disabled.

*4: The CPU/Windows10 Upgrade Retrofit MG3710E-182/282 option is required when the MG3710E OS is not Windows 10.

*5: Replace the MG3710E CPU board with Windows Embedded Standard 7 (Windows 7) and upgrade the operating system to Windows 10 IoT Enterprise LTSC2019.
Windows 7 is installed in MG3710E units ordered until August 2020.

Windows 10 is installed in MG3710E units ordered from September 2020 and has a label indicating C2 attached near the serial number.

Easy-to-use Panel

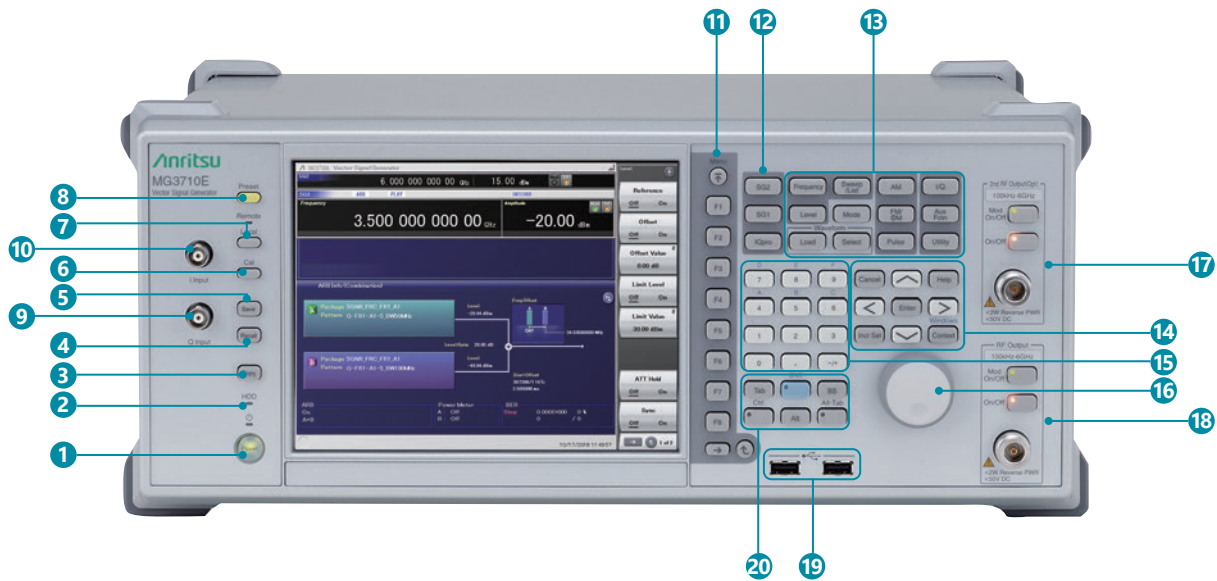

- 1 Power Switch**
Switches between standby status in which AC power is supplied, and operating power-on status. At standby the key lamp is orange; at power-on it is green. To supply power press the switch for 2 seconds or more.
- 2 HDD/SSD Lamp**
Lit when internal storage device (HDD or SSD) being accessed.
- 3 Copy Key**
Copies screen display to file.
- 4 Recall Key**
Displays menu for recalling parameter files.
- 5 Save Key**
Displays menu for saving parameter files.
- 6 Cal Key**
Displays menu for performing calibration.
- 7 Local Key/Remote Lamp**
Local Key: Return remote control via GPIB, Ethernet, USB (B) to local control and enables panel setting.
Remote Lamp: Lit while MG3710E under remote control.
- 8 Preset Key**
Displays Preset menu to initialize parameter settings.
- 9 Q Input Connector**
Input for external Q phase signal. Requires MG3710E-018 and only supports SG1 (1stRF); does not support SG2 (2ndRF).
- 10 I Input Connector**
Input for external I phase signal. Requires MG3710E-018 and only supports SG1 (1stRF); does not support SG2 (2ndRF).
- 11 Function Keys**
Select and execute functions displayed at right edge of display. Displayed functions menus are multi-level with page hierarchy.
- 12 SG1/SG2/IQpro Keys**
SG1: Switches setting target to SG1
SG2: Switches setting target to SG2
IQpro: Starts IQproducer on main unit. IQproducer may not start running for a few seconds to minutes after pressing this key.
- 13 Main Function Keys**
Displays menus for setting and executing main functions: Frequency], [Level], [Sweep/List], [Mode], [AM], [FM/ΦM], [Pulse], [I/Q], [Load], [Select], [AUX Fctn], [Utility]
- 14 Arrow/Enter/Cancel/Help/Incr Set/Context/Windows Keys**
Help: Pressing function key after Help key displays help for pressed function key
Incr Set: Sets increment/decrement steps for each parameter
Context: Performs same operation and right mouse click
Windows: Performs same operation as Windows key
- 15 Ten Key Pad**
Input numeric values for each parameter setting screen.
- 16 Rotary Knob**
Selects and sets displayed items.
- 17 2nd RF Output [MG3710E-062/064/066]**
Mod On/Off: Switched 1stRF/2ndRF modulation On/Off.
Lamp lit during modulation.
On/Off: Switches RF output On/Off.
- 18 RF Output [MG3710E-032/034/036]**
- 19 USB Connector (Type A)**
- 20 Tab/Alt/BS/Ctrl/Shift/Alt-Tab Key**
Shift key: Executes panel operation indicated by blue characters. Press Shift key and then required key.

Easy-to-use Panel

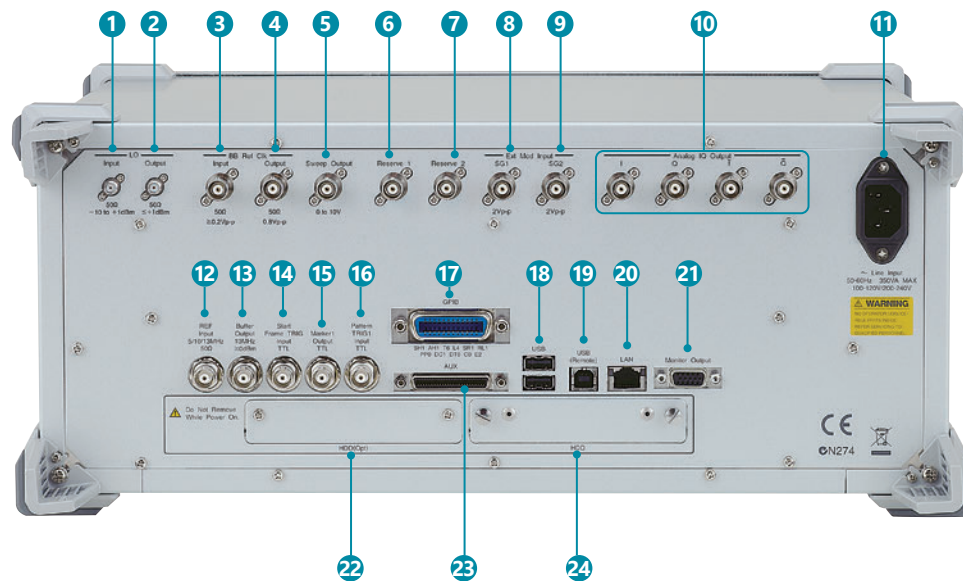

- 1 LO Input**
Connector for inputting external Local signal. Requires [MG3710E-017](#).
- 2 LO Output**
Outputs Local signal. Requires [MG3710E-017](#).
- 3 BB REF CLK Input**
Connector for inputting reference clock signal for sampling clock of built-in arbitrary waveform generator. Requires [MG3710E-017](#).
- 4 BB REF CLK Output**
Connector for outputting arbitrary waveform generator sampling clock signal. Requires [MG3710E-017](#).
- 5 Sweep Output**
Connector for outputting either 10 V Sweep Signal synchronized with Sweep or Sweep Status signal. Requires [MG3710E-017](#).
- 6 Reserve 1**
Terminal for future extension.
- 7 Reserve 2**
Terminal for future extension.
- 8 Ext Mod Input SG1**
Option connector for inputting external signal for additional analog modulation input for the SG1. Requires [MG3710E-050](#).
- 9 Ext Mod Input SG2**
Option connector for inputting external signal for additional analog modulation input for the SG2. Requires [MG3710E-080](#).
- 10 I Output/Q Output/ \bar{T} Output/ \bar{Q} Output**
Connector for outputting internal baseband I/Q signal or inverse I/Q signal. Requires [MG3710E-018](#).
- 11 AC Inlet**
- 12 REF Input**
Connector for inputting external reference frequency signal (5/10/13 MHz).
- 13 Buffer Output**
Connector for outputting built-in reference frequency signal (10 MHz).
- 14 Start Frame TRIG Input**
Connector (pulled up internally) for inputting external trigger signal.
- 15 Marker 1 Output**
Connector for outputting Marker 1 signal. (Marker 2/3 output from AUX connector). Requires [AUX Conversion Adapter J1539A](#).
- 16 Pattern TRIG 1 Input**
Connector (pulled up internally) for inputting external trigger signal.
- 17 GPIB**
Connector Connector used for remote control via GPIB.
- 18 USB Connector (Type A)**
Connector for USB memory, keyboard, mouse, etc.
- 19 USB Connector (Type B)**
Connector used for remote control via USB.
- 20 LAN**
Connector for personal computer and network.
- 21 Monitor Output**
RGB connector for external display.
- 22 HDD (Opt)**
Slot for HDD or SSD for saving data. Also supports 2ndary HDD MG3710E-011/111 options.
- 23 AUX**
Connector for following I/O signals. Requires [AUX Conversion Adapter J1539A](#).
 - BER Measurement Signal (Input): Data, CLK, Enable
 - Marker Signal (Output): Marker 2, Marker 3
 - Pulse Signal for external Pulse Modulation (Input): Pulse Mod
 - Signal synchronized with Pulse Modulation signal at PM (Output): Pulse Sync, Pulse Video Out
 - Trigger signal at timing of internal Baseband Ref Clock based on Start/Frame trigger (Out): Sync Trigger Out
- 24 HDD/SSD**
Slot for HDD or SSD to save OS, applications, waveform data, etc. Units with an SSD label at the top have an internal SSD; all other units have an internal HDD*1. Also supports Removable HDD, Win10 MG3710E-014/114/214 option. *1: MG3710E units ordered from March 2025 have an internal SSD.

Specifications

Refer to the Data Sheet for specification details such as guaranteed setting ranges, etc.

Frequency Setting Range

1stRF

MG3710E-032 9 kHz to 2.7 GHz

MG3710E-034 9 kHz to 4 GHz

MG3710E-036 9 kHz to 6 GHz

2ndRF

MG3710E-062 9 kHz to 2.7 GHz

MG3710E-064 9 kHz to 4 GHz

MG3710E-066 9 kHz to 6 GHz

Switching Speed (List Mode)

Frequency ≤600 μs

Level ≤600 μs

Amplitude Setting Range

Options	Setting Range [dBm]	
	without Reverse Power Protection	with Reverse Power Protection
Standard	-110 to +17	-110 to +17
with High-power Extension	-110 to +30	-110 to +25
with Low-power Extension	-144 to +17	-144 to +17
with High-power Extension and Low-power Extension	-144 to +30	-144 to +25

Level Accuracy is assured at high levels (CW)

Frequency Range	Standard	MG3710E-041/071
100 kHz ≤ f < 10 MHz	+5 dBm	+5 dBm
10 MHz ≤ f < 50 MHz	+10 dBm	+10 dBm
50 MHz ≤ f < 400 MHz	+13 dBm	+20 dBm
400 MHz ≤ f ≤ 3 GHz		+23 dBm
3 GHz < f ≤ 4 GHz		+20 dBm
4 GHz < f ≤ 5 GHz	+11 dBm	+13 dBm
5 GHz < f ≤ 6 GHz		+11 dBm

Absolute Level Accuracy (at CW, 18°C to 28°C, -110 to +5 dBm)

±0.5 dB (typ.) (100 kHz ≤ f < 50 MHz)

±0.5 dB (50 MHz ≤ f ≤ 3 GHz)

±0.7 dB (3 GHz < f ≤ 4 GHz)

±0.8 dB (4 GHz < f ≤ 6 GHz)

Harmonics

<-30 dBc

Non-Harmonics

Output level ≤+5 dBm, CW, Frequency offset ≥10 kHz

<-62 dBc (100 kHz ≤ f ≤ 187.5 MHz)

<-68 dBc (187.5 MHz < f ≤ 750 MHz)

<-62 dBc (750 MHz < f ≤ 1.5 GHz)

<-56 dBc (1.5 GHz < f ≤ 3 GHz)

<-50 dBc (3 GHz < f ≤ 6 GHz)

Single Sideband Phase Noise (at CW, 20 kHz offset)

<-140 dBc/Hz (nom.) (100 MHz)

<-131 dBc/Hz (typ.) (1 GHz)

<-125 dBc/Hz (typ.) (2 GHz)

Analog Modulation

Amplitude Modulation (Internal Modulation Source)

Depth: 0 to 100% (Linear)

0 to 10 dB (Log)

Modulation Frequency: 0.1 Hz to 50 MHz

Frequency Modulation (Internal Modulation Source)

Deviation: 0 Hz to 40 MHz

Modulation Frequency: 0.1 Hz to 40 MHz, or (50-MHz FM Rate), whichever smaller

Φ-Modulation (Internal Modulation Source)

Deviation angle: 0 to 160 rad., or (40 MHz/ΦM Rate) rad., whichever smaller

Modulation Frequency: 0.1 Hz to 40 MHz, or (40 MHz/ΦM Deviation), whichever smaller

Pulse Modulation (Internal Modulation Source)

Modulation Frequency: 0.1 Hz to 10 MHz

Modulation Period: 10 ns to 20 s

Baseband Performance

RF Modulation Bandwidth

160 MHz*/120 MHz (using Internal baseband signal generator)

ARB Memory Size

64 Msamples (256 MB) [with 1stRF, 2ndRF]

256 Msamples (1 GB) [MG3710E-045/075]

1024 Msamples (4 GB) [MG3710E-046/076]

Sampling Rate

20 kHz to 200 MHz*/160 MHz

DAC Resolution

14/15/16 bits

*: Supports firmware version 2.00.00 and later. Only when using WLAN I/Qproducer MX370111A and 802.11ac (160 MHz) option MX370111A-002.

EVM Performance

18°C to 28°C, after CAL

W-CDMA (Test Model 4):

Output Frequency: 800 MHz to 900 MHz, 1.8 GHz to 2.2 GHz

≤0.62%(rms)

≤0.6%(rms) (typ.)

GSM:

Output Frequency: 800 MHz to 900 MHz, 1.8 GHz to 1.9 GHz

≤0.84%(rms)

≤0.8%(rms) (typ.)

EDGE:

Output Frequency: 800 MHz to 900 MHz, 1.8 GHz to 1.9 GHz

≤0.84%(rms)

≤0.8%(rms) (typ.)

LTE (20 MHz Test Model 3.1):

Output Frequency: 600 MHz to 2.7 GHz

≤0.82%(rms)

≤0.8%(rms) (typ.)

Dimensions, Weight

177 (H) × 426 (W) × 390 (D) mm

≤13.7 kg (with 1stRF, excluding other option)

Power Requirements

100 V(ac) to 120 V(ac), 200 V(ac) to 240 V(ac)

50 Hz to 60 Hz

CE Marking

EMC: 2014/30/EU, EN61326-1, EN61000-3-2

LVD: 2014/35/EU, EN61010-1

RoHS: 2011/65/EU, (EU) 2015/863, EN IEC 63000: 2018

UKCA Marking

EMC: S.I. 2016 No.1091, EN 61326-1, EN61000-3-2

LVD: S.I. 2016 No.1101, EN 61010-1

RoHS: S.I. 2012 No.3032, EN IEC 63000: 2018

Ordering Information

Please specify the model/order number, name and quantity when ordering.
The names listed in the chart below are Order Names. The actual name of the item may differ from the Order Name.

Model/Order No.	Name	Remarks
MG3710E	Main Unit Vector Signal Generator	
P0031A	Standard Accessories Power Cord: 1 pc USB Memory Install CD-ROM	USB2.0 Flash Driver, ≥256 MB Operation manual (PDF) and application software (IQproducer)
MG3710E-001 MG3710E-002 MG3710E-011 MG3710E-014	Options (Common Parts) Rubidium Reference Oscillator High Stability Reference Oscillator 2ndary HDD Removable HDD, Win10	Select when ordering main unit, aging rate: $\pm 1 \times 10^{-10}$ /month Select when ordering main unit, aging rate: $\pm 1 \times 10^{-7}$ /year Select when ordering main unit, spare storage device for saving user data without Windows OS Select when ordering main unit.
MG3710E-017	Universal Input/Output	This secondary storage device option can be installed in place of the standard built-in storage device containing user data when repairing or calibrating the MG3710E to prevent risks of user-data leaks when user data must not be taken offsite. Select when ordering main unit, Adds BNC connectors for following signals to rear panel of main unit, includes AUX Conversion Adapter J1539A
MG3710E-021	BER Test Function	(Baseband Reference Clock Input/Output, Sweep Output, Local Signal Input/Output) Select when ordering main unit, Built-in BER measurement, Bit Rate: 100 bps to 40 Mbps AUX Conversion Adapter J1539A as standard accessory J1539A required for Data/Clock/Enable signal input
MG3710E-101 MG3710E-102 MG3710E-111 MG3710E-114	Rubidium Reference Oscillator Retrofit High Stability Reference Oscillator Retrofit 2ndary HDD Retrofit Removable HDD, Win10 Retrofit	Retrofitted to shipped MG3710E Retrofitted to shipped MG3710E Retrofitted to shipped MG3710E Retrofitted to shipped MG3710E
MG3710E-214	Removable HDD, Win10 Retrofit	When retrofitting the MG3710E-114/214, the MG3710E main unit without the removed HDD/SSD can be returned to Anritsu. The CPU/Windows10 Upgrade Retrofit MG3710E-182/282 option is required when the MG3710E OS is not Windows 10. Retrofitted to shipped MG3710E When retrofitting the MG3710E-114/214, the MG3710E main unit without the removed HDD/SSD can be returned to Anritsu. The CPU/Windows10 Upgrade Retrofit MG3710E-182/282 option is required when the MG3710E OS is not Windows 10. MG3710E-2xx is the option for customers to upgrade at their nearest local service center outside Japan.
MG3710E-117 MG3710E-121	Universal Input/Output Retrofit BER Test Function Retrofit	Retrofitted to shipped MG3710E Retrofitted to shipped MG3710E AUX Conversion Adapter J1539A as standard accessory J1539A required for Data/Clock/Enable signal input
MG3710E-182 MG3710E-282	CPU/Windows10 Upgrade Retrofit CPU/Windows10 Upgrade Retrofit	Retrofitted to shipped MG3710E Retrofitted to shipped MG3710E Option 2xx is the option for customers to upgrade at their nearest local service center outside Japan.
MG3710E-032 MG3710E-034 MG3710E-036	(For 1stRF) 1stRF 100 kHz to 2.7 GHz 1stRF 100 kHz to 4 GHz 1stRF 100 kHz to 6 GHz	Select when ordering main unit, select 1stRF frequency range, frequency cannot be changed after installation Select when ordering main unit, select 1stRF frequency range, frequency cannot be changed after installation Select when ordering main unit, select 1stRF frequency range, frequency cannot be changed after installation
MG3710E-041 MG3710E-042 MG3710E-043	High Power Extension for 1stRF Low Power Extension for 1stRF Reverse Power Protection for 1stRF	Select when ordering main unit, increases upper limit of output signal power setting range Select when ordering main unit, increases lower limit of output signal power setting range Select when ordering main unit, prevents damage caused by reverse input to output connector
MG3710E-045 MG3710E-046 MG3710E-048 MG3710E-049 MG3710E-050	ARB Memory Upgrade 256 Msample for 1stRF ARB Memory Upgrade 1024 Msample for 1stRF Combination of Baseband Signal for 1stRF AWGN for 1stRF Additional Analog Modulation Input for 1stRF	Select when ordering main unit, expands ARB memory capacity Select when ordering main unit, expands ARB memory capacity Select when ordering main unit, adds baseband combine function Select when ordering main unit, adds AWGN combine function Select when ordering main unit, Adds BNC connector for inputting external signals to rear panel of main unit.
MG3710E-018 MG3710E-141 MG3710E-142 MG3710E-143 MG3710E-145 MG3710E-146 MG3710E-148 MG3710E-149 MG3710E-150 MG3710E-118	Analog IQ Input/Output High Power Extension for 1stRF Retrofit Low Power Extension for 1stRF Retrofit Reverse Power Protection for 1stRF Retrofit ARB Memory Upgrade 256 Msample for 1stRF Retrofit ARB Memory Upgrade 1024 Msample for 1stRF Retrofit Combination of Baseband Signal for 1stRF Retrofit AWGN for 1stRF Retrofit Additional Analog Modulation Input for 1stRF Retrofit Analog IQ Input/Output Retrofit	Select when ordering main unit, installs IQ input/output BNC connector in main unit Retrofitted to shipped MG3710E Retrofitted to shipped MG3710E Retrofitted to shipped MG3710E Retrofitted to shipped MG3710E Retrofitted to shipped MG3710E Retrofitted to shipped MG3710E Retrofitted to shipped MG3710E Retrofitted to shipped MG3710E Retrofitted to shipped MG3710E Retrofitted to shipped MG3710E

Ordering Information

Model/Order No.	Name	Remarks
MG3710E-062	(For 2ndRF) 2ndRF 100 kHz to 2.7 GHz	Select when ordering main unit, select 2ndRF frequency range, frequency cannot be changed after installation
MG3710E-064	2ndRF 100 kHz to 4 GHz	Select when ordering main unit, select 2ndRF frequency range, frequency cannot be changed after installation
MG3710E-066	2ndRF 100 kHz to 6 GHz	Select when ordering main unit, select 2ndRF frequency range, frequency cannot be changed after installation
MG3710E-071	High Power Extension for 2ndRF	Select when ordering main unit, increases upper limit of output signal power setting range
MG3710E-072	Low Power Extension for 2ndRF	Select when ordering main unit, increases lower limit of output signal power setting range
MG3710E-073	Reverse Power Protection for 2ndRF	Select when ordering main unit, prevents damage caused by reverse input to output connector
MG3710E-075	ARB Memory Upgrade 256 Msample for 2ndRF	Select when ordering main unit, expands ARB memory capacity
MG3710E-076	ARB Memory Upgrade 1024 Msample for 2ndRF	Select when ordering main unit, expands ARB memory capacity
MG3710E-078	Combination of Baseband Signal for 2ndRF	Select when ordering main unit, adds baseband combine function
MG3710E-079	AWGN for 2ndRF	Select when ordering main unit, adds AWGN combine function
MG3710E-080	Additional Analog Modulation Input for 2ndRF	Select when ordering main unit, Adds BNC connector for inputting external signals to rear panel of main unit.
MG3710E-162	2ndRF 100 kHz to 2.7 GHz Retrofit	Retrofitted to shipped MG3710E when 2ndRF not installed
MG3710E-164	2ndRF 100 kHz to 4 GHz Retrofit	Retrofitted to shipped MG3710E when 2ndRF not installed
MG3710E-166	2ndRF 100 kHz to 6 GHz Retrofit	Retrofitted to shipped MG3710E when 2ndRF not installed
MG3710E-171	High Power Extension for 2ndRF Retrofit	Retrofitted to shipped MG3710E
MG3710E-172	Low Power Extension for 2ndRF Retrofit	Retrofitted to shipped MG3710E
MG3710E-173	Reverse Power Protection for 2ndRF Retrofit	Retrofitted to shipped MG3710E
MG3710E-175	ARB Memory Upgrade 256 Msample for 2ndRF Retrofit	Retrofitted to shipped MG3710E
MG3710E-176	ARB Memory Upgrade 1024 Msample for 2ndRF Retrofit	Retrofitted to shipped MG3710E
MG3710E-178	Combination of Baseband Signal for 2ndRF Retrofit	Retrofitted to shipped MG3710E
MG3710E-179	AWGN for 2ndRF Retrofit	Retrofitted to shipped MG3710E
MG3710E-180	Additional Analog Modulation Input for 2ndRF Retrofit	Retrofitted to shipped MG3710E
	Maintenance Service	
MG3710E-ES210	2 Years Extended Warranty Service	
MG3710E-ES310	3 Years Extended Warranty Service	
MG3710E-ES510	5 Years Extended Warranty Service	
	Softwares (Waveform Pattern)	
MX370073B	DFS Radar Pattern	(License for waveform patterns) WLAN 5.3/5.6 GHz band DFS tests (for FCC and Japan MIC) waveform pattern, license for main unit, manual (PDF)
MX370075A	DFS (ETSI) Waveform Pattern	WLAN 5.3/5.6 GHz DFS test (ETSI) waveform pattern, license for main unit, manual (PDF)
MX370084A	ISDB-Tmm Waveform Pattern	ISDB-Tmm Waveform Patterns, license for main unit, manual (PDF)
MX371054A	Interference Waveform Pattern for LTE Receiver Test	3GPP-compliant modulated interference signal for LTE UE receiver sensitivity and throughput tests, license for main unit, manual (PDF)
MX371055A	Interference Waveform Pattern for 5G NR Receiver Test	3GPP-compliant modulated interference signal for 5G UE receiver sensitivity and throughput tests, license for main unit, manual (PDF)
	Softwares (IQproducer)	
MX370101A	HSDPA/HSUPA IQproducer	(License for IQproducer) IQproducer software, license for main unit, manual (PDF)
MX370102A	TDMA IQproducer	IQproducer software, license for main unit, manual (PDF)
MX370104A	Multi-carrier IQproducer	IQproducer software, license for main unit, manual (PDF)
MX370106A	DVB-T/H IQproducer	IQproducer software, license for main unit, manual (PDF)
MX370107A	Fading IQproducer	IQproducer software, license for main unit, manual (PDF)
MX370108A	LTE IQproducer	IQproducer software, license for main unit, manual (PDF)
MX370108A-001	LTE-Advanced FDD Option	IQproducer software, license for main unit, manual (PDF). Requires MX370108A.
MX370110A	LTE TDD IQproducer	IQproducer software, license for main unit, manual (PDF)
MX370110A-001	LTE-Advanced TDD Option	IQproducer software, license for main unit, manual (PDF). Requires MX370110A.
MX370111A	WLAN IQproducer	IQproducer software, license for main unit, manual (PDF)
MX370111A-002	802.11ac (160 MHz) Option	IQproducer software, license for main unit, manual (PDF). Only for MG3710E/MG3710A. Requires MX370111A
MX370112A	TD-SCDMA IQproducer	IQproducer software, license for main unit, manual (PDF)
MX370113A	5G NR TDD sub-6 GHz IQproducer	IQproducer software, license for main unit, manual (PDF)
MX370114A	5G NR FDD sub-6 GHz IQproducer	IQproducer software, license for main unit, manual (PDF)

Ordering Information

Model/Order No.	Name	Remarks
	Optional Accessories	
W3580AE	MG3710A/MG3710E/MG3740A Operation Manual (Main Unit)	Booklet, for MG3710A/MG3710E/MG3740A Main unit (Operation, Remote Control)
W2496AE	MG3710A/MG3710E/MG3740A Operation Manual (IQproducer)	Booklet, for IQproducer (Operation for Common Parts)
W3581AE	MG3710A/MG3710E Operation Manual (Pre-installed Waveform Patterns)	Booklet, for Pre-installed Waveform Patterns (Usage, Detailed Parameters)
W3986AE	MX370073B Operation Manual	Booklet, for DFS (for FCC and Japan MIC) Waveform Patterns
W3597AE	MX370075A Operation Manual	Booklet, for DFS (ETSI) Waveform Patterns
W3508AE	MX370084A Operation Manual	Booklet, for ISDB-Tmm Waveform Patterns
W4073AE	MX371054A Operation Manual	Booklet, for Interference Waveform Pattern for LTE Receiver Test
W4074AE	MX371055A Operation Manual	Booklet, for Interference Waveform Pattern for 5G NR Receiver Test
W2915AE	MX370101A Operation Manual	Booklet, for HSDPA/HSUPA IQproducer
W2916AE	MX370102A Operation Manual	Booklet, for TDMA IQproducer
W2917AE	MX370104A Operation Manual	Booklet, for Multi-carrier IQproducer
W2798AE	MX370106A Operation Manual	Booklet, for DVB-T/H IQproducer
W2995AE	MX370107A Operation Manual	Booklet, for Fading IQproducer
W3023AE	MX370108A Operation Manual	Booklet, for LTE IQproducer/LTE-Advanced FDD Option
W3221AE	MX370110A Operation Manual	Booklet, for LTE TDD IQproducer/LTE-Advanced TDD Option
W3488AE	MX370111A Operation Manual	Booklet, for WLAN IQproducer/802.11ac Option
W3582AE	MX370112A Operation Manual	Booklet, for TD-SCDMA IQproducer
W3984AE	MX370113A Operation Manual	Booklet, for 5G NR TDD sub-6 GHz IQproducer
W4033AE	MX370114A Operation Manual	Booklet, for 5G NR FDD sub-6 GHz IQproducer
J1539A	AUX Conversion Adapter	Converts MG3710E/MG3710A rear-panel AUX connector to BNC connector
Z1572A	Installation Kit	Requires when retrofitting hardware options or installing IQproducer/Waveform Pattern
Z1594A	Standard Waveform Pattern for Backup	Latest MG3710E/MG3710A Pre-installed waveform pattern set for backup
MA24105A	Inline Peak Power Sensor	350 MHz to 4 GHz, Inline type, with USB A to micro-B Cable
MA24106A	USB Power Sensor	50 MHz to 6 GHz, with USB A to mini-B Cable
MA24108A	Microwave USB Power Sensor	10 MHz to 8 GHz, with USB A to micro-B Cable
MA24118A	Microwave USB Power Sensor	10 MHz to 18 GHz, with USB A to micro-B Cable
MA24126A	Microwave USB Power Sensor	10 MHz to 26 GHz, with USB A to micro-B Cable
K240B	Power Divider (K connector)	DC to 26.5 GHz, K-J, 50Ω, 1 Wmax
J0576B	Coaxial Cord, 1.0 m	N-P · 5D-2W · N-P
J0576D	Coaxial Cord, 2.0 m	N-P · 5D-2W · N-P
J0127A	Coaxial Cord, 1.0 m	BNC-P · RG-58A/U · BNC-P
J0127B	Coaxial Cord, 2.0 m	BNC-P · RG-58A/U · BNC-P
J0127C	Coaxial Cord, 0.5 m	BNC-P · RG-58A/U · BNC-P
J0322A	Coaxial Cord, 0.5 m	SMA-P · SMA-P, DC to 18 GHz, 50Ω
J0322B	Coaxial Cord, 1.0 m	SMA-P · SMA-P, DC to 18 GHz, 50Ω
J0322C	Coaxial Cord, 1.5 m	SMA-P · SMA-P, DC to 18 GHz, 50Ω
J0322D	Coaxial Cord, 2.0 m	SMA-P · SMA-P, DC to 18 GHz, 50Ω
J0004	Coaxial Adapter	N-P · SMA-J Conversion Adapter, DC to 12.4 GHz
J1261B	Ethernet Cable (Shield Type)	Straight-through, 3 m
J1261D	Ethernet Cable (Shield Type)	Crossover, 3 m
J0008	GPIB Cable, 2.0 m	
B0635A	Rack Mount Kit	EIA
B0657A	Rack Mount Kit (JIS)	JIS
B0636C	Carrying Case	Hard Type. With Casters and Front Cover B0671A
B0671A	Front Cover for 1MW4U	
Z0541A	USB Mouse	

The following option is installed as standard when ordering the MG3710E. It does not require a separate order.

MX371099A MG3710A Standard Waveform Pattern

Requires Installation Kit Z1572A when retrofitting options or installing IQproducer/Waveform Pattern.

The instruction manuals are published on our website except some.

Typical (typ.): Performance not warranted. Must products meet typical performance.

Nominal (nom.): Values not warranted. Included to facilitate application of product.

Measured (meas): Performance not warranted. Data actually measured by randomly selected measuring instruments.

Trademarks:

- IQproducer™ is a registered trademark of Anritsu Corporation.
- MATLAB® is a registered trademark of The MathWorks, Inc.
- CDMA2000® is a registered trademark of the Telecommunications Industry Association (TIA-USA).
- The Bluetooth® mark and logos are owned by Bluetooth SIG, Inc. and are used by Anritsu under license.
- Pentium® is registered trademarks of Intel Corporation or its subsidiaries in the USA and other countries.
- Windows® is a registered trademark of Microsoft Corporation in the USA and other countries.
- Other companies, product names and service names are registered trademarks of their respective companies.

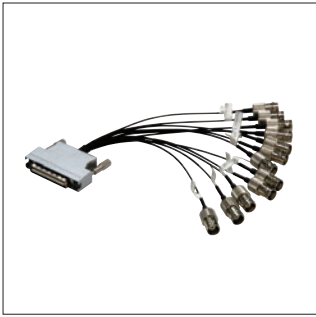

AUX Conversion Adapter J1539A



USB Power Sensor MA24106A



Carrying Case B0636C
(Hard type, with casters)



MG3710E with Front Cover
Front Cover for 1MW4U B0671A

Anritsu Advancing beyond

Specifications are subject to change without notice.

• United States

Anritsu Americas Sales Company
490 Jarvis Drive, Morgan Hill, CA 95037-2809, U.S.A.
Phone: +1-800-Anritsu (1-800-267-4878)

• Canada

**Anritsu Electronics Ltd.
Americas Sales and Support**
490 Jarvis Drive, Morgan Hill, CA 95037-2809, U.S.A.
Phone: +1-800-Anritsu (1-800-267-4878)

• Brazil

Anritsu Eletrônica Ltda.
Praça Amadeu Amaral, 27 - 1 Andar
01327-010 - Bela Vista - Sao Paulo - SP, Brazil
Phone: +55-11-3283-2511
Fax: +55-11-3288-6940

• Mexico

Anritsu Company, S.A. de C.V.
Blvd Miguel de Cervantes Saavedra #169 Piso 1, Col. Granada
Mexico, Ciudad de Mexico, 11520, MEXICO
Phone: +52-55-4169-7104

• United Kingdom

Anritsu EMEA Limited
900 Capability Green, Luton, Bedfordshire, LU1 3LU, U.K.
Phone: +44-1582-433200
Fax: +44-1582-731303

• France

Anritsu SA
12 avenue du Québec, Immeuble Goyave,
91140 VILLEBON SUR YVETTE, France
Phone: +33-1-60-92-15-50

• Germany

Anritsu GmbH
Nemetschek Haus, Konrad-Zuse-Platz 1,
81829 München, Germany
Phone: +49-89-442308-0
Fax: +49-89-442308-55

• Italy

Anritsu S.R.L.
Spaces Eur Arte, Viale dell'Arte 25, 00144 Roma, Italy
Phone: +39-6-509-9711

• Sweden

Anritsu AB
Kistagången 20 B, 2 tr, 164 40 Kista, Sweden
Phone: +46-8-534-707-00

• Finland

Anritsu AB
Technopolis Aviapolis, Teknobulevardi 3-5 (D208.5),
FI-01530 Vantaa, Finland
Phone: +358-20-741-8100

• Denmark

Anritsu A/S
c/o Regus Winghouse, Ørestads Boulevard 73, 4th floor,
2300 Copenhagen S, Denmark
Phone: +45-7211-2200

• Spain

**Anritsu EMEA GmbH
Representation Office in Spain**
Calle Manzanares 4, Primera planta, 28005 Madrid, Spain
Phone: +34-91-572-6761

• Austria

Anritsu EMEA GmbH
Am Belvedere 10, A-1100 Vienna, Austria
Phone: +43-(0)1-717-28-710

• United Arab Emirates

Anritsu A/S
Office No. 164, Building 17, Dubai Internet City
P. O. Box – 501901, Dubai, United Arab Emirates
Phone: +971-4-3758479

• India

ANRITSU INDIA PRIVATE LIMITED
6th Floor, Indiqube ETA, No.38/4, Adjacent to EMC2,
Doddanekundi, Outer Ring Road, Bengaluru – 560048, India
Phone: +91-80-6728-1300
Fax: +91-80-6728-1301

• Singapore

ANRITSU PTE LTD
1 Jalan Kilang Timor, #07-04/06 Pacific Tech Centre
Singapore 159303
Phone: +65-6282-2400
Fax: +65-6282-2533

• Vietnam

ANRITSU COMPANY LIMITED
16th Floor, Peakview Tower, 36 Hoang Cau Street, O Cho Dua Ward,
Dong Da District, Hanoi, Vietnam
Phone: +84-24-3201-2730

• P.R. China (Shanghai)

Anritsu (China) Co., Ltd.
Room 2301-2303, Tower A, New Caohejing International Business
Center No. 391 Gui Ping Road, Shanghai, 200233, P.R. China
Phone: +86-21-6237-0898
Fax: +86-21-6237-0899

• P.R. China (Hong Kong)

ANRITSU COMPANY LIMITED
Unit 1302, 13th Floor, New East Ocean Center,
No.9 Science Museum Road, TsimShaTsui East,
Kowloon, Hong Kong
Phone: +852-2301-4980
Fax: +852-2301-3545

• Japan

Anritsu Corporation
8-5, Tamura-cho, Atsugi-shi, Kanagawa, 243-0016 Japan
Phone: +81-46-296-6509
Fax: +81-46-225-8352

• Korea

Anritsu Corporation Limited
8F, A TOWER, 20, Gwacheondaero 7-gil, Gwacheon-si,
Gyeonggi-do, 13840, Republic of Korea
Phone: +82-2-6259-7300
Fax: +82-2-6259-7301

• Australia

Anritsu Pty Ltd
Unit 20, 21-35 Ricketts Road, Mount Waverley, Victoria 3149, Australia
Phone: +61-3-9558-8177
Fax: +61-3-9558-8255

• Taiwan

ANRITSU COMPANY, INC.
7F, No. 316, Sec. 1, NeiHu Rd., Taipei 114, Taiwan
Phone: +886-2-8751-1816
Fax: +886-2-8751-1817