

Anritsu Advancing beyond

Analog Signal Generator

MG3740A

100 kHz to 2.7 GHz

100 kHz to 4.0 GHz

100 kHz to 6.0 GHz



Excellent RF Performance Versatile Modulation Functions Built-in Dual RF Outputs*

Supports Narrowband Digital as well as CW and Analog Modulations !



Dual RF*

Wanted + interference wave Rx characteristics tests, Amp intermodulation characteristics evaluation, RF/LO signal source for Mixer evaluations.

SSB Phase Noise Performance

<-140 dBc/Hz (nom.) [100 MHz, 20 kHz offset]
<-131 dBc/Hz (typ.) [1 GHz, 20 kHz offset]

Output Level Setting Range

-144 to +25 dBm [Option installed]

Analog/Pulse Modulation

Supports AM/FM/ΦM/Pulse modulation functions as well as option for expansion to dual internal modulation (AM/FM/ΦM) and single external modulation systems.

*: Option installed

The Analog Signal Generator MG3740A has excellent RF specifications, including SSB Phase Noise, output level, etc., and versatile modulation functions (AM/FM/ΦM/Pulse).

High-Purity Signal Source for Testing Analog Radio

The excellent SSB phase noise performance supports narrowband radio Rx sensitivity suppression tests.

<-140 dBc/Hz (nominal) [100 MHz, 20-kHz offset, CW]

Excellent level accuracy over a wide level range, the MG3740A is the solution for accurate tests of radio Rx sensitivity and amplifier distortion characteristics.

Setting Range: -144 to +25 dBm
(CW, MG3740A-041/071, 042/072, 043/073 installed)

Cuts Tact Time

To shorten tact times on production lines the MG3740A supports two standard modes.

The List/Sweep mode switches the frequency and level faster than 600 μs.

Cut Equipment Costs

The dual RF outputs supporting wanted + interference waves for tests of Rx characteristics, evaluation of wireless and amplifier intermodulation characteristics, and output of RF/LO signals for mixer tests, cut test costs by eliminating the need for two signal generators.

Extendible Narrowband Digital Modulation Function

Adding the digital modulation option adds a digital modulation signal generator function providing a cost-effective solution for testing public safety digital radio systems.

Digital Modulation Performance
RF Modulation Bandwidth: 2 MHz
Sampling Rate: 20 kHz to 8 MHz

Main Applications

- Testing Rx characteristics of analog radio
- Testing amplifier distortion and intermodulation characteristics
- RF/LO Signal source for evaluating mixer characteristics
- Testing Rx characteristics of narrowband digital radio

Key Features

Basic Performance

SSB Phase Noise Performance

<-140 dBc/Hz (nom.) @100 MHz, 20-kHz offset, CW
<-131 dBc/Hz (typ.) @1 GHz, 20-kHz offset, CW
<-125 dBc/Hz (typ.) @2 GHz, 20-kHz offset, CW

High-power Output [MG3740A-041/071]

+23 dBm @CW, 400 MHz to 3 GHz

High-speed Switching

< 600 μ s @List/Sweep mode

High Level Accuracy

Absolute Level Accuracy: ± 0.5 dB
Linearity: ± 0.2 dB (typ.)

Choice of Reference Oscillators

Standard

Aging rate $\pm 1 \times 10^{-6}$ /year, $\pm 1 \times 10^{-7}$ /day

High Stability Reference Oscillator [MG3740A-002]

Aging rate $\pm 1 \times 10^{-7}$ /year, $\pm 1 \times 10^{-8}$ /day

Rubidium Reference Oscillator [MG3740A-001]

Aging rate $\pm 1 \times 10^{-10}$ /month

Dual RF

One Unit Supports Two RF Outputs Max.

Frequency Range

1stRF: 100 kHz to 2.7 GHz [MG3740A-032]

100 kHz to 4.0 GHz [MG3740A-034]

100 kHz to 6.0 GHz [MG3740A-036]

2ndRF: 100 kHz to 2.7 GHz [MG3740A-062]

100 kHz to 4.0 GHz [MG3740A-064]

100 kHz to 6.0 GHz [MG3740A-066]

Independent Baseband and RF Outputs

Expandability

Analog/Pulse Modulation Functions [Standard]

Supports built-in analog modulation (AM/FM/ Φ M) functions and pulse modulation (PM) functions.

Adding additional analog modulation input options

(MG3740A-050/080) supports modulation by external signal input.

USB Power Sensors [Sold separately]

Up to two USB power sensors can be connected to the MG3740A and the results are displayed on the MG3740A screen.

Frequency Range: 600 MHz to 4 GHz [MA24104A]*

350 MHz to 4 GHz [MA24105A]

50 MHz to 6 GHz [MA24106A]

10 MHz to 8 GHz [MA24108A]

10 MHz to 18 GHz [MA24118A]

10 MHz to 26 GHz [MA24126A]

*: MA24104A has been discontinued. Replacement model is MA24105A.

Operability

Simple Touch-panel Operation

Touching the easy-to-use GUI with hierarchical menus fetches related function and numeric input keys for simple fast settings.

Signal Flowcharts with Signal Block Diagrams

Intuitive Hardware Block Chart screens make it easy to grasp settings and signal paths at a glance.

Frequency Channel Table

A built-in channel table with presettings for popular communications systems simplifies frequency settings by using channel numbers.

Connections with External Equipment

Remote Control Interfaces

GPIO, Ethernet (1000BASE-T), and USB (Type B) interfaces on the rear panel offer versatile choices for operation by remote control.

USB Connections

Two Type A USB2.0 connectors on each of the front and rear panels offer convenient connections for keyboard, mouse and USB memory.

Expansion to Digital Modulation Signal Generator

The MG3740A Analog Signal Generator can be expanded to add digital modulation signal generation functions, supporting evaluation of digital public safety radio systems.

Digital Modulation [MG3740A-020]

Adding the digital modulation option [MG3740A-020] supports generation of digital modulation signals by outputting narrowband digital modulation signals.

Digital Modulation Performance

RF Modulation Bandwidth: 2 MHz

Sampling Rate: 20 kHz to 8 MHz

Waveform generation software: IQproducer (License sold separately)

TDMA IQproducer

Fading IQproducer

BER Test Function [MG3740A-021]

This option measures Bit Error Rate (BER) using Data/Clock/Enable demodulated at the DUT to display the results on the MG3740A screen.

Input bit rate: 100 bps to 40 Mbps

Output Two Signals from One RF Out [MG3740A-048/078]

The baseband signal combine option installs two waveform memories for either the 1stRF (or 2ndRF) SG to combine two waveform patterns as the baseband for output, eliminating the need for two separate signal generators.

Wanted Signal + Interfere Signal

Wanted Signal + Delayed Signal, etc.

Basic Performance

SSB Phase Noise

- <-140 dBc/Hz (nom.) @100 MHz, 20-kHz offset, CW
- <-131 dBc/Hz (typ.) @1 GHz, 20-kHz offset, CW
- <-125 dBc/Hz (typ.) @2 GHz, 20-kHz offset, CW

SSB phase noise is an important performance index for signal generators. For example, when using a signal generator for the following purposes, it is important to pre-confirm that the signal generator performance satisfies the measurement specifications.

- Communications with narrow bandwidth of several kHz
- CW interference waveforms
- Full range of reference and local signals

Single sideband phase noise

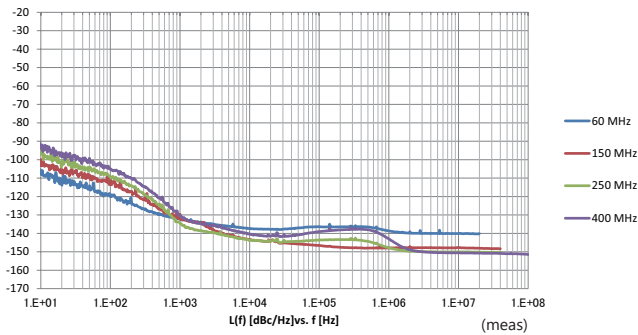

Single sideband phase noise

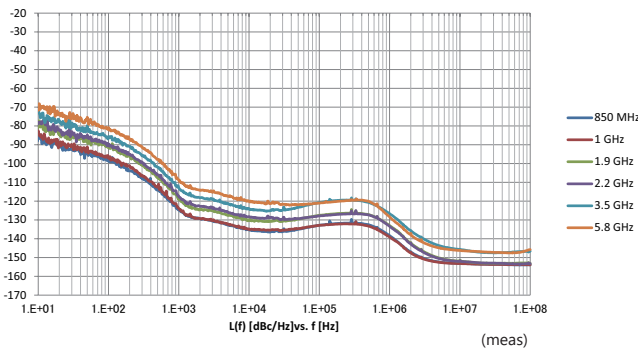

Example: SSB Phase Noise

(Phase Noise Optimization <200 kHz, CW, Optimize S/N Off, with MG3740A-002)

Low-power Output [MG3740A-042*1/072*2]

- *1: Low Power Extension for 1stRF [MG3740A-042]
- *2: Low Power Extension for 2ndRF [MG3740A-072]

Amplitude Setting Range

Options	Setting Range [dBm]	
	without Reverse Power Protection*3	with Reverse Power Protection*3
Standard	-110 to +17	-110 to +17
with High-power Extension	-110 to +30	-110 to +25
with Low-power Extension	-144 to +17	-144 to +17
with High-power Extension and Low-power Extension	-144 to +30	-144 to +25

*3: Reverse Power Protection for 1stRF/2ndRF [MG3740A-043/073]

The MG3740A supports a convenient option for extending the lower RF output limit when performing high-sensitivity Rx tests.

High-power Output [MG3740A-041*1/071*2]

- *1: High Power Extension for 1stRF [MG3740A-041]
- *2: High Power Extension for 2ndRF [MG3740A-071]

Level Accuracy is assured at high levels (CW)

Frequency Range	Standard	MG3740A-041/071
100 kHz ≤ f < 10 MHz	+5 dBm	+5 dBm
10 MHz ≤ f < 50 MHz	+10 dBm	+10 dBm
50 MHz ≤ f < 400 MHz	+13 dBm	+20 dBm
400 MHz ≤ f ≤ 3 GHz		+23 dBm
3 GHz < f ≤ 4 GHz		+20 dBm
4 GHz < f ≤ 5 GHz		+13 dBm
5 GHz < f ≤ 6 GHz	+11 dBm	+11 dBm

These options expand the MG3740A RF output upper limit. They are used when compensating for level losses of parts in the measurement path.

Maximum output power

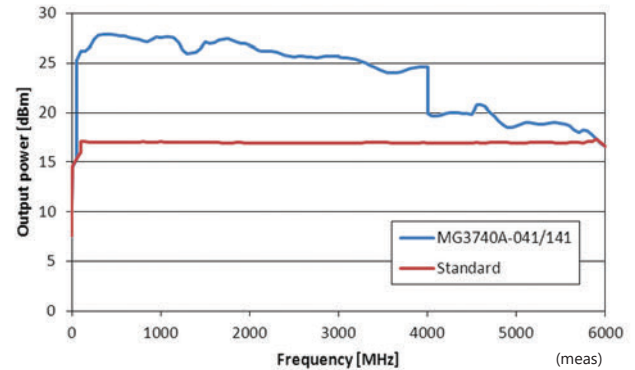

Supports Rubidium Reference Oscillator (Option)

Three reference oscillator options are supported. Select the high-stability reference oscillator option [MG3740A-002] when requiring high accuracy depending on the measurement conditions; for even higher accuracy, select the rubidium reference oscillator [MG3740A-001]. However, if external high-accuracy reference signals are available, selecting the standard reference oscillator option helps reduce unnecessary costs.

Reference Oscillator

Standard

- Aging Rate: $\pm 1 \times 10^{-6}$ /year, $\pm 1 \times 10^{-7}$ /day
- Temperature Stability: $\pm 2.5 \times 10^{-6}$ (5°C to 45°C)

High Stability Reference Oscillator [MG3740A-002]

- Aging Rate: $\pm 1 \times 10^{-7}$ /year, $\pm 1 \times 10^{-8}$ /day
- Temperature Stability: $\pm 2 \times 10^{-8}$ (5°C to 45°C)
- Start-up Characteristics*: $\pm 5 \times 10^{-7}$ (2 minutes after power-on)
- $\pm 5 \times 10^{-8}$ (5 minutes after power-on)

Rubidium Reference Oscillator [MG3740A-001]

- Aging Rate: $\pm 1 \times 10^{-10}$ /month
- Temperature Stability: $\pm 2 \times 10^{-9}$ (5°C to 45°C)
- Start-up Characteristics*: $\pm 1 \times 10^{-9}$ (7.5 minutes after power-on)

*: Compared to frequency after 24-h warm-up at 23°C

Basic Performance

High Level Accuracy

Absolute Level Accuracy: ± 0.5 dB*1

Linearity: ± 0.2 dB (typ.)*2

*1: 400 MHz to 3 GHz, -110 to +10 dBm

*2: 50 MHz to 3 GHz, -110 to -1 dBm

Excellent level accuracy and linearity are key factors with a large impact on measurement accuracy.

Level accuracy at 0dBm

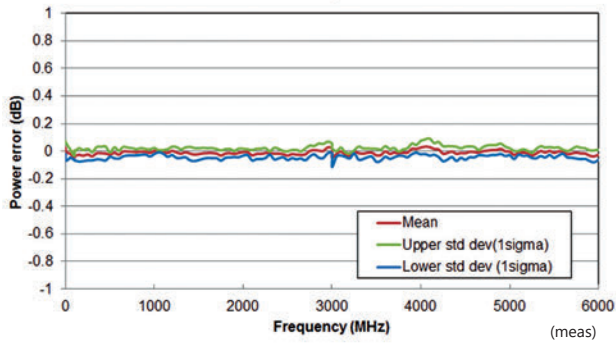

Relative level accuracy at 850 MHz initial power +10 dBm

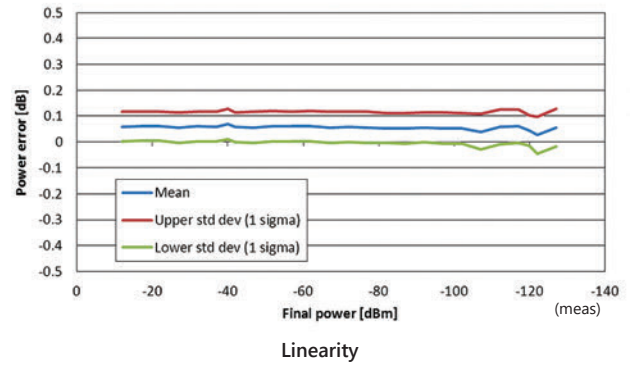

Level accuracy at -112 dBm

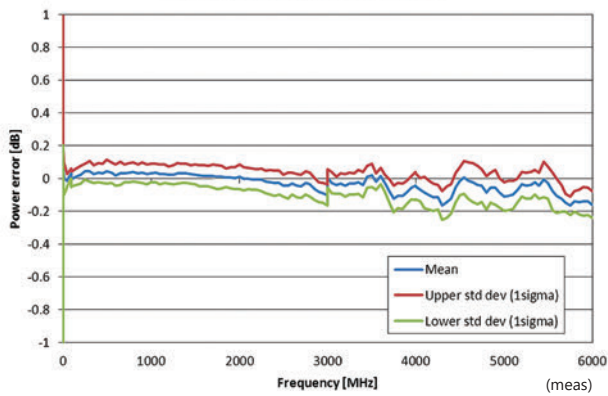

Amplitude repeatability +5 dBm ALC on

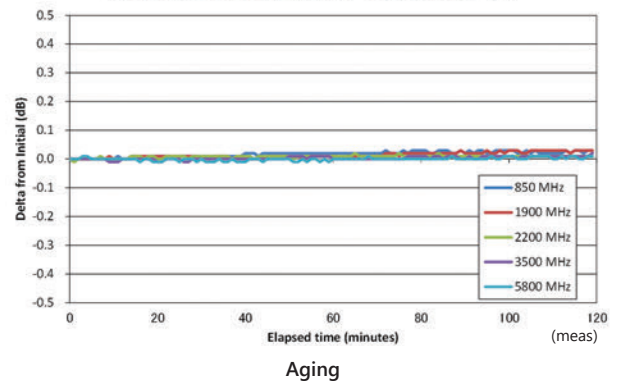

Frequency Characteristic

Aging

Basic Performance

High-speed Switching

<600 μs @List/Sweep mode

To shorten tact times on production lines the MG3740A supports two standard modes each with high-speed frequency and level switching.

Sweep Mode

In this mode, the dwell time per point or number of points is split between the frequency range and level range (Start/Stop). This mode is used when matching dwell time per point and frequency/level steps.

Frequency Range

Level Range

Points:
2 to 1000 (Sawtooth)
2 to 500 (Triangle)

Dwell Time:
100 μs to 16 s

Step Shape:
Sawtooth
Triangle

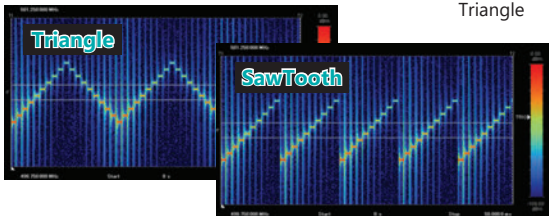

10 points, 500-μs Dwell Time

List Mode

In this mode, the frequency, level and dwell time can be set for each of up to 500 points. This mode is used when wanting to set any dwell time, and frequency/level step per point.

ID	Frequency	Level	Dwell
1	900,000,000 MHz	-10.00 dBm	100 μs
2	900,500,000 MHz	-10.00 dBm	2 μs
3	900,000,000 MHz	-10.00 dBm	2 μs
4	900,500,000 MHz	-10.00 dBm	2 μs
5	900,000,000 MHz	-10.00 dBm	2 μs

5 points, Any Dwell Time

Dual VSG: Two RF Outputs

The MG3740A supports two RF outputs (1stRF/2ndRF) max. in one unit. Moreover, different frequencies can be set independently at 1stRF and 2ndRF.

Not only different frequencies but also different levels and modulations can be set independently at each SG while each is tracking the other. The all-in-one MG3740A eliminates the need for two conventional signal generators when requiring wanted + interference waveforms for evaluating Rx signal characteristics, testing intermodulation characteristics of radio equipment and amplifiers, and generating RF/LO signals for evaluating mixers.

Notes: Supported frequency bands cannot be changed after shipment. IQ input is supported only by SG1 (1stRF) and requires MG3740A-017.



2ndRF

Frequency Range:
100 kHz to 2.7 GHz [MG3740A-062]
100 kHz to 4.0 GHz [MG3740A-064]
100 kHz to 6.0 GHz [MG3740A-066]

* Whether or not install and the frequency model can be selected at any time.

1stRF

Frequency Range:
100 kHz to 2.7 GHz [MG3740A-032]
100 kHz to 4.0 GHz [MG3740A-034]
100 kHz to 6.0 GHz [MG3740A-036]

* Must install any one of these.

Expandability

AM/FM/ΦM/Pulse Function

This option supports the following modulation functions as standard. Analog modulation (AM/FM/ΦM) is supported using both CW and internal modulation signals.

Pulse modulation can be performed at any cycle or timing and also supports modulation using an external input signal.

Amplitude Modulation (Internal Modulation Source)

Depth: 0 to 100% (Linear)
0 to 10 dB (Exponential)

Modulation Frequency: 0.1 Hz to 50 MHz

Frequency Modulation (Internal Modulation Source)

Deviation: 0 to 40 MHz
Modulation Frequency: 0.1 Hz to 40 MHz, or (50 MHz-FM Rate), whichever smaller

Φ-Modulation (Internal Modulation Source)

Deviation angle: 0 to 160 rad.
or (40 MHz/ΦM Rate) rad., whichever smaller

Modulation Frequency: 0.1 Hz to 40 MHz,
or (40 MHz/ΦM Deviation), whichever smaller

Pulse Modulation (Internal Modulation Source)

Modulation Frequency: 0.1 Hz to 10 MHz

Modulation Period: 10 ns to 20 s

Additional Analog Modulation Input [MG3740A-050/080]

Adding additional analog modulation input options (MG3740A-050/080) extends to two internal modulation sources (AM/FM/ΦM) and one external modulation source supporting simultaneous two-signal modulation. This is used when superimposing tone squelch signals.

- AM + FM
- AM + ΦM
- Internal 1 + Internal 2
- Internal + External

* FM + ΦM does not support.

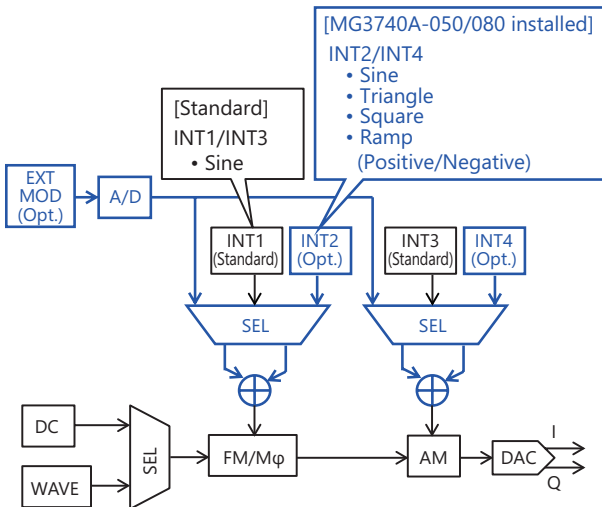

USB Power Sensors [Sold separately]

Up to two USB power sensors can be connected to the MG3740A to display the measurement results on the MG3740A screen.

USB Power Sensor

Model	Frequency Range	Dynamic Range
MA24104A*	600 MHz to 4 GHz	+3 to +51.76 dBm
MA24105A	350 MHz to 4 GHz	+3 to +51.76 dBm
MA24106A	50 MHz to 6 GHz	-40 to +23 dBm
MA24108A	10 MHz to 8 GHz	-40 to +20 dBm
MA24118A	10 MHz to 18 GHz	-40 to +20 dBm
MA24126A	10 MHz to 26 GHz	-40 to +20 dBm

*: MA24104A has been discontinued. Replacement model is MA24105A.

Level Offset: -100 to +100 dB

Average: 1 to 2048

Unit: dBm, W

COM Port: 2 to 8

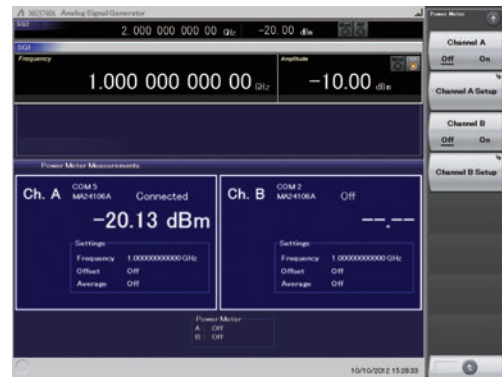
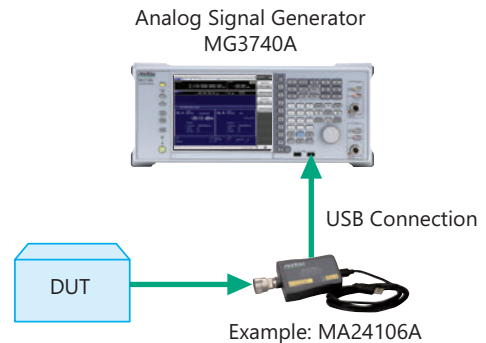

Power Meter Measurement Screen

Easy Touch-panel Operation

Simply touching parts of the screen display with a finger fetches related function keys and numeric inputs, offering a fast and easy way of navigating through multilayer menus.

Frequency Setting

Level Setting

AM/FM/ΦM/Pulse Function

Power Meter Function

BER Function [MG3740A-021]

Signal Flowcharts

The Hardware Block Chart provides an intuitive at-a-glance understanding of the settings and signals for each block (Analog Mod, Pulse Mod, Local, etc.)



Hardware Block Chart Screen

Frequency Channel Table

Sometimes frequencies need setting by Channel No. The built-in frequency channel table where frequencies are set by channel number is ideal for this application. Once set and saved, these pre-settings can be read whenever needed.

Channel Table Setting

- Group: 1 to 19
- Start Channel: 0 to 20000
- End Channel: (Start Channel) to 20000
- Start Frequency
- Channel Spacing

Connection with External Equipment

Remote Control Interfaces

The MG3740A has GPIB, Ethernet and USB interfaces as standard, supporting the following functions:

- Control all functions, except power switch
- Read all status conditions and settings
- Interrupts and serial polls

While in the Local status, the interface is determined automatically by the communication start command from the external controller (PC). To change the interface, put the MG3740A into the Local status again by pressing the Local key on the front panel and then send a command via the desired interface.

GPIB: Conforms to IEEE488.1/IEEE488.2 standards

SH1, AH1, T6, L4, SR1, RL1, PP0, DC1, DT0, C0, E2

Ethernet: Conforms to VXI-11 protocol using TCP/IP Control programs

SH1, AH1, T6, L4, SR1, RL1, PP0, DC1, DT0, C0

USB: Conforms to USBTMC-USB488 protocols

SH1, AH1, T6, L4, SR1, RL1, PP0, DC1, DT0, C0n

USB Connections

The two type-A USB2.0 connectors on the front and rear panels support keyboard, mouse and USB memory connections. Supported USB power sensors can be connected too.

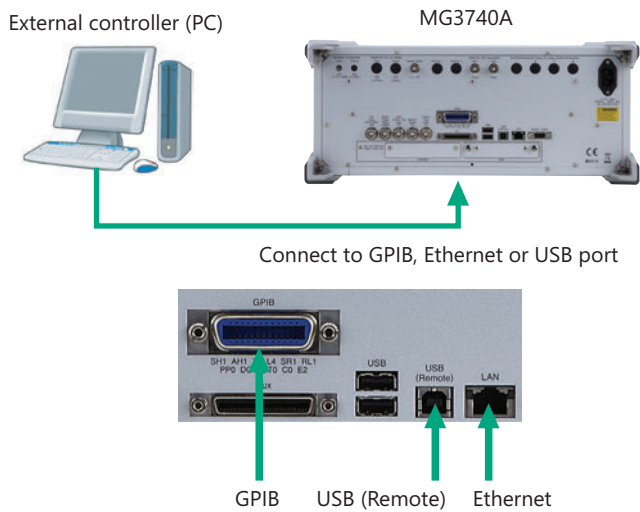

To remotely control the MG3740A, either select the SCPI mode command format defined by the SCPI Consortium, or select backwards compatible modes supporting earlier MG3700A, MS269xA, MS2830A, and MG364xA commands

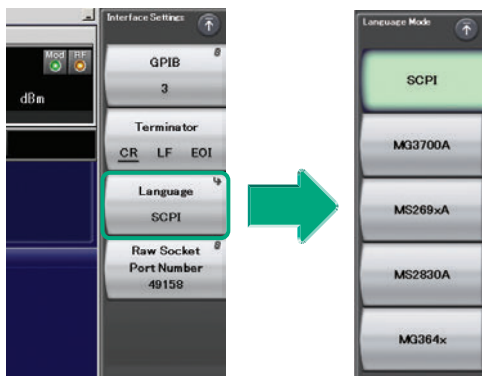

Command Format Setting Example

Analog Radio Rx Characteristics Tests

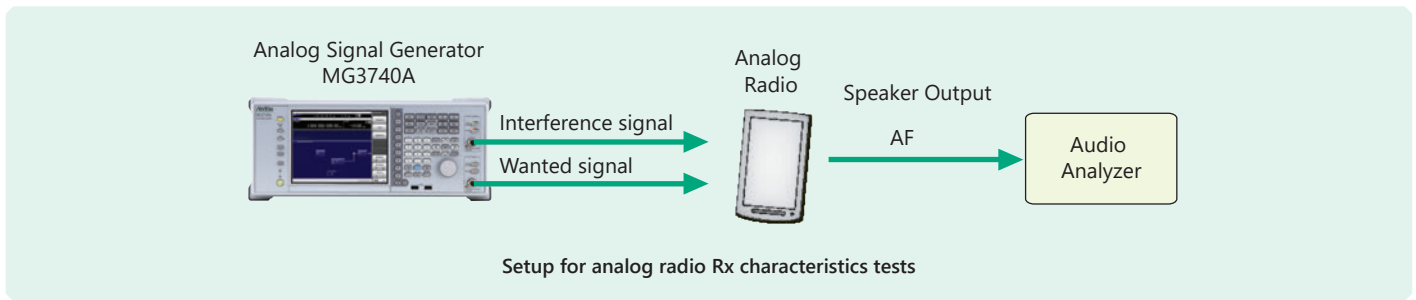

The MG3740A outputs RF signals for radio operation verification tests and evaluation of Rx characteristics, when the radio AF output can be measured with an external audio analyzer.



High-Purity Signal Source for Testing Analog Radio

Supports SSB Phase Noise Performance -140 dBc/Hz nom. (@100 MHz)
Phase noise performance affects measurement results at narrow bandwidths of several kHz. In particular, high phase-noise performance is required for interference waveforms.

The excellent SSB phase noise performance supports narrowband radio Rx sensitivity suppression tests.

- -140 dBc/Hz (nom.) @100 MHz, 20-kHz offset, CW
- -131 dBc/Hz (typ.) @1 GHz, 20-kHz offset, CW
- -125 dBc/Hz (typ.) @2 GHz, 20-kHz offset, CW

The excellent level accuracy over a wide output level range supports accurate Rx sensitivity tests.

- Amplitude setting range: -110 to $+17$ dBm (Standard)
- -144 to $+17$ dBm (with MG3740A-042/072)

- Absolute level accuracy: ± 0.5 dB*1
- Linearity 1: ± 0.2 dB (typ)*2

*1: 400 MHz to 3 GHz, -110 to $+10$ dBm
*2: 50 MHz to 3 GHz, -110 to -1 dBm

Supports Maximum Two RF Outputs

The dual RF outputs of the all-in-one MG3740A help cut infrastructure costs by eliminating the need for two signal sources when outputting wanted + interference waves for RX characteristics tests, and evaluating intermodulation characteristics, etc. Additionally, there is no need for troublesome settings at each of two separate signal generators helping cut operation time and costs using the frequency/level synchronization function.

AM/FM/ΦM/Pulse Function (Standard)

Supports built-in analog modulation (AM/FM/ΦM) functions and pulse modulation (PM) functions.

Adding additional analog modulation input options (MG3740A-050/080) supports modulation by external signal input. This is used when superimposing tone squelch signals.

- AM + FM
- AM + ΦM
- Internal 1 + Internal 2
- Internal + External

* FM + ΦM does not support.

Analog Radio Main Rx Characteristics Evaluation Items

Test Items	Key MG3740A Features	
Sensitivity	✓	Wide level range, High level accuracy, Internal modulation function (standard)
Passing Bandwidth, Attenuation	✓	High level accuracy, Frequency offset setting function
AF Level	✓	Internal modulation function (standard)
Demodulation Frequency Characteristics	✓	Internal modulation function (standard)
Demodulation Distortion	✓	Internal modulation function (standard)
Demodulation S/N	✓	Internal modulation function (standard), External modulation function (Option)
Spurious Response	✓	High level accuracy, Internal modulation function (standard)
Sensitivity Suppression Effect	✓	Dual RF, Low SSB Phase Noise *All-in-one evaluation without requiring two separate signal sources.
Intermodulation Characteristics	✓	Dual RF, Low SSB Phase Noise *Two units of MG3740A support evaluation without requiring three separate signal sources.

Reference Signal Generator for Evaluating Characteristics of Amplifiers, Mixers, etc.

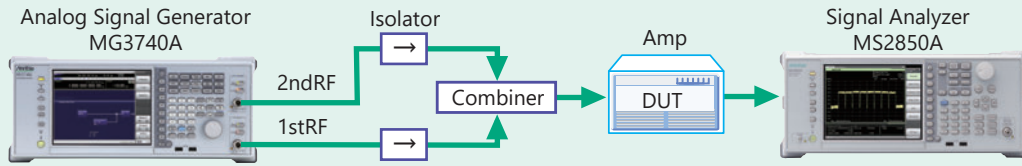

Setup for evaluating intermodulation characteristics of amplifier

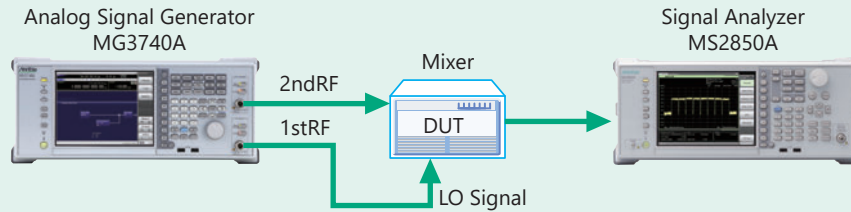

Setup for evaluating distortion characteristics of Mixer

The dual RF outputs of the MG3740A are ideal for evaluating intermodulation (IM3) characteristics of amplifiers, etc., as well as for use as RF/LO signal sources for testing mixers, eliminating the need for two separate signal generators. The high-performance MS2850A Signal Analyzer series is recommended for intermodulation and harmonic wave distortion measurements.



Supports Maximum Two RF Outputs

Usually, two general signal generators are required to output two continuous waveforms when evaluating the intermodulation characteristics of amplifiers, etc., or for use as RF/LO signal sources at mixer tests. A maximum of two RF outputs (1stRF/2ndRF) can be installed in the MG3740A and the product lineup includes models with different 1stRF and 2ndRF frequencies. Different frequencies and levels can be set at the two signal outputs and the frequency/level synchronization function cuts the setting workload too.



USB Power Sensor

Up to two USB power sensors (separately sold) can be connected to the MG3740A.

USB connectors to display the measurement results on the MG3740A screen.

Model	Frequency Range	Dynamic Range
MA24104A*	600 MHz to 4 GHz	+3 to +51.76 dBm
MA24105A	350 MHz to 4 GHz	+3 to +51.76 dBm
MA24106A	50 MHz to 6 GHz	-40 to +23 dBm
MA24108A	10 MHz to 8 GHz	-40 to +20 dBm
MA24118A	10 MHz to 18 GHz	-40 to +20 dBm
MA24126A	10 MHz to 26 GHz	-40 to +20 dBm

*: MA24104A has been discontinued. Replacement model is MA24105A.

High-power Output Option (MG3740A-041/071) Supports CW Levels of +23 dBm

In general, an external amp is required when the output of a signal generator is insufficient, such as covering the measurement system transmission path loss and inputting high-level modulation signals for amp distortion characteristics tests. Since the output of an external amp cannot be assured, it must be checked with a power meter each time the frequency and level are changed. Moreover, when using an external amp, sometimes the DUT may be damaged by mishandling errors. The MG3740A high-power output supports signals required for measuring path loss. In addition, stable measurement is assured when used within the guaranteed setting range. And the risk of mistakenly damaging the DUT is reduced, even at the output limit.

Expansion to Digital Modulation Signal Generator

The MG3740A Analog Signal Generator can be expanded to add digital modulation generation functions, supporting evaluation of digital public safety radio systems. All-in-one support for both analog and digital tests maximizes equipment investment efficiency.

Digital Modulation [MG3740A-020]

Adding the digital modulation option [MG3740A-020] supports generation of digital modulation signals by outputting narrowband digital modulation signals.

Digital Modulation Performance

- RF Modulation Bandwidth: 2 MHz
- Sampling Rate: 20 kHz to 8 MHz

Dual Waveform Memory: Four Waveform Outputs Max.

In the standard configuration, one RF (1stRF or 2ndRF) has one waveform memory. However, adding the baseband signal combine option (MG3740A-048/078) upgrades to two memories for one RF. In other words, models with two RFs (1stRF and 2ndRF) installed can have a maximum of four waveform memories. Two waveform patterns can be set easily on-screen for one RF, each with different frequency offset, level offset and delay time settings to output a combined baseband RF signal. With this setup, one MG3740A supports the following test environment — a setup that previously required two signal generators:

- Wanted Signal + Interference Signal
- Wanted Signal + Delayed Signal

Waveform Generation Software (Separate license)

The IQproducer system provides an easy-to-use GUI for setting parameters according to each communications method. The parameter setting results file can be saved as a file for easy recall later.

* For detail, refer to the IQproducer brochure.

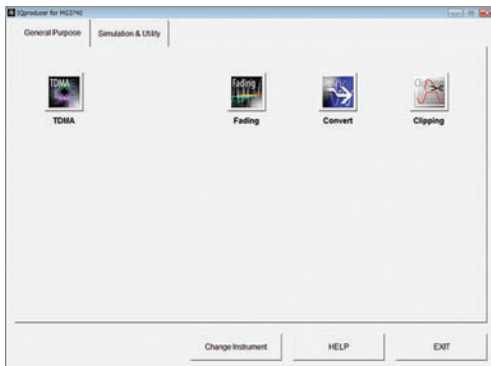

IQproducer Main Screen

[MG3740A Option IQproducer]

- MX370102A TDMA IQproducer

Sets required parameters for TDMA waveform patterns and generates various waveform patterns.

- MX370107A Fading IQproducer

Performs IQ channel fading processing, correlation matrix calculation, AWGN combination.

BER Test Function [MG3740A-021]

This option installs a BER measurement function for measuring error rates between 100 bps and 40 Mbps using the DUT demodulated Data/Clock/Enable signals. The results are displayed on the MG3740A screen.

Input Bit Rate: 100 bps to 40 Mbps

Input Signal: Data, Clock, Enable (Polarity reversal supported)

Input Level: TTL

Input Connector: BNC-J

Measured Patterns:

- PN9/11/15/20/23, ALL1, ALL0,
- Alternate (0101...), User Data,
- PN9fix/11fix/15fix/20fix/23fix

Count Mode

- Data: Measures until specified Data count
- Error: Measures until specified Error count

Measurable Bit Count: $\leq 2^{32} - 1$ (4,294,967,295 bits)

Measurement Mode

- Single: Measures specified measurement bit count once
- Continuous: Repeats Single measurement
- Endless: Continues measurement to upper limit of measurement bits

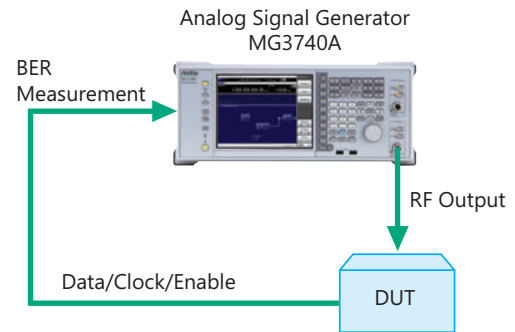

The BER can be measured using the DUT-demodulated Data/Clock/Enable.

BER Measurement Upper Limit

The table below shows one example of a BER measurement that indicates SyncLoss. Actual results depend on the specific communication systems and data rate, and will not necessarily match the measurement values below.

Error Rate	PN9	PN11	PN15	PN20	PN23
6.0%	—	—	—	—	—
5.0%	ok	—	—	—	—
4.0%	ok	ok	—	—	—
3.0%	ok	ok	ok	—	—
2.5%	ok	ok	ok	—	—
2.0%	ok	ok	ok	ok	ok
1.0%	ok	ok	ok	ok	ok

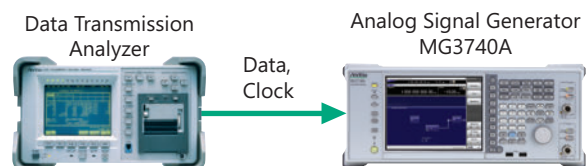

Expansion to Digital Modulation Signal Generator

Key Differences from Vector Signal Generator MG3710E

Installing the Digital Modulation Option (MG3740A-020) in the MG3740A Analog Signal Generator adds the functions of a digital modulation signal generator. The key differences in the main functions compared to the conventional MG3710E Vector Signal Generator are listed below.

Key Functional Differences between MG3740A Analog Signal Generator and MG3710E Vector Signal Generator

	Analog Signal Generator MG3740A	Vector Signal Generator MG3710E*1	Remarks
Frequency Range	100 kHz to 2.7 GHz (MG3740A-032/062) 100 kHz to 4.0 GHz (MG3740A-034/064) 100 kHz to 6.0 GHz (MG3740A-036/066)	100 kHz to 2.7 GHz (MG3710E-032/062) 100 kHz to 4.0 GHz (MG3710E-034/064) 100 kHz to 6.0 GHz (MG3710E-036/066)	Supports two signal generators (1stRF/2ndRF output) in one unit
Analog Modulation Internal Source	[Standard]	[Standard]	AM, FM/ΦM Each one internal source
Additional Analog Modulation Input	[MG3740A-050/080]	[MG3710E-050/080]	Extends to one external input, two internal source (AM, FM/ΦM)
Digital Modulation	[MG3740A-020] Digital modulation performance - RF modulation bandwidth: 2 MHz - Sampling rate: 20 kHz to 8 MHz	[Standard] Digital modulation performance - RF modulation bandwidth: 160 MHz*2/120 MHz - Sampling rate: 20 kHz to 200 MHz*2/160 MHz	
Pre-installed Waveform Patterns	No	Yes	LTE FDD/TDD (E-TM1.1 to E-TM3.3) W-CDMA/HSDPA, GSM/EDGE, CDMA2000 1X/1xEV-DO, WLAN (IEEE802.11a/11b/11g), etc.
Waveform pattern/IQproducer	TDMA IQproducer Fading IQproducer	Listed below	Listed below
ARB Memory Upgrade (per RF)	[MG3740A-045/075] Max. 256 Msamples	[MG3710E-046/076] Max. 1024 Msamples	Standard: 64 Msamples
Combination of Baseband Signal	[MG3740A-048/078]	[MG3710E-048/078]	
AWGN Generator	No	[MG3710E-049/079]	
Analog IQ Input/Output	No	[MG3710E-018]	
Universal Input/Output	[MG3740A-017] - Sweep Output (1stRF) - AUX-BNC conversion adapter	[MG3710E-017] - Baseband Reference Clock Input/Output - Sweep Output (1stRF) - Local Signal Input/Output - AUX-BNC conversion adapter	
BER Measurement Function	[MG3740A-021]	[MG3710E-021]	

*1: The MG3710E Vector Signal Generator is recommended for many purposes. For detail, refer to the MG3710E product brochure.

*2: Only when using MX370111A WLAN IQproducer and MX370111A-002 802.11ac (160 MHz) option.

Waveform Pattern Support Systems

Main unit support Waveform Pattern

Waveform pattern Support Systems	MG3740A (with MG3740A-020)	MG3710E
MX370073B DFS Radar Pattern	—	✓
MX370075A DFS (ETSI) Waveform Pattern	—	✓

For detail, refer to the MX3700xxA Waveform pattern product brochure.

IQproducer Support Systems

Main unit support IQproducer

IQproducer Support Systems	MG3740A (with MG3740A-020)	MG3710E
Standard Accessories	W-CDMA IQproducer	✓
	AWGN IQproducer	✓
Options	MX370101A HSDPA/HSUPA IQproducer	✓
	MX370102A TDMA IQproducer	✓
	MX370104A Multi-carrier IQproducer	✓
	MX370106A DVB-T/H IQproducer	✓
	MX370107A Fading IQproducer	✓
	MX370108A LTE IQproducer	✓
	MX370108A-001 LTE-Advanced FDD Option	✓
	MX370110A LTE TDD IQproducer	✓
	MX370110A-001 LTE-Advanced TDD Option	✓
	MX370111A WLAN IQproducer	✓
	MX370111A-002 802.11ac (160 MHz) Option	✓
	MX370112A TD-SCDMA IQproducer	✓
	MX370113A 5G NR TDD sub-6 GHz IQproducer	✓
	MX370114A 5G NR FDD sub-6 GHz IQproducer	✓

For detail, refer to the MX3701xxA IQproducer product brochure.

Recommended Configuration

Excellent Expandability

Supports both Analog and Narrowband Digital Modulation

The MG3740A can be tailored to various applications, ranging from evaluation of analog modulation radio systems to narrowband digital modulation radio systems by adding cost-effective options.

Application Examples and Options

Option Configuration		Main Applications		
Model	Name	Analog Modulation Radio Systems	Analog/Digital Modulation Radio Systems	Analog/Digital Modulation Radio Systems and CW Interference Signal (2RF)
MG3740A	Analog Signal Generator	✓	✓	✓
MG3740A-032	1stRF 100 kHz to 2.7 GHz	✓	✓	✓
MG3740A-042/142	Low Power Extension for 1stRF/Retrofit	✓	✓	✓
MG3740A-043/143	Reverse Power Protection for 1stRF / Retrofit	✓	✓	✓
MG3740A-050/150	Additional Analog Modulation Input for 1stRF/Retrofit	✓	✓	✓
MG3740A-020/120	Digital Modulation/Retrofit		✓	✓
MG3740A-021/121	BER Test Function/Retrofit		✓	✓
MG3740A-062/162	2ndRF 100 kHz to 2.7 GHz/Retrofit			✓
MG3740A-073/173	Reverse Power Protection for 2ndRF/Retrofit			✓
MX370102A	TDMA IQproducer		✓	✓

Options

Hardware (Common)

Rubidium Reference Oscillator MG3740A-001
Rubidium Reference Oscillator Retrofit MG3740A-101

Installs 10 MHz reference crystal oscillator with excellent frequency stability startup characteristics of $\pm 1 \times 10^{-9}$ at 7.5 minutes after power-on.

Aging Rate: $\pm 1 \times 10^{-10}$ /month
 Temperature stability: $\pm 2 \times 10^{-9}$ (5°C to 45°C)
 Start-up characteristics*: $\pm 1 \times 10^{-9}$ (7.5 minutes after power-on)

*: at 23°C, compared to frequency after 24 h warm-up

High Stability Reference Oscillator MG3740A-002
High Stability Reference Oscillator Retrofit MG3740A-102

Installs 10 MHz reference oscillator with better frequency stability as follows..

Aging Rate: $\pm 1 \times 10^{-7}$ /year, $\pm 1 \times 10^{-8}$ /day
 Temperature stability: $\pm 2 \times 10^{-8}$ (5°C to 45°C)
 Start-up characteristics*: $\pm 5 \times 10^{-7}$ (2 minutes after power-on)
 $\pm 5 \times 10^{-8}$ (5 minutes after power-on)

*: at 23°C, compared to frequency after 24 h warm-up

2ndary HDD MG3740A-011
2ndary HDD Retrofit MG3740A-111

This removable storage device is installed in the HDD Option Slot of the MG3740A main unit to expand the user data storage space.

It does not have the Windows OS installed. The MG3740A ships with it installed. Only one expansion HDD can be installed in the MG3740A. It is useful when taking the instrument for calibration but the security of saved user data, such as measurement results, must be protected.

Removable HDD, Win10 MG3740A-014
Removable HDD, Win10 Retrofit MG3740A-114
Removable HDD, Win10 Retrofit MG3740A-214

This additional user-changeable storage device contains the same Windows OS and programs as the factory installed system storage device. It supports a Windows 10 install for one specific MG3740A and is for use during service repair and calibration.

Universal Input/Output MG3740A-017
Universal Input/Output Retrofit MG3740A-117

Installs sweep signal output connector on rear panel of main unit. Outputs Sweep Output signal synchronized with sweep. (only supports SG1)

*: Also provides AUX Conversion Adapter J1539A for MG3740A-017/117 to use rear-panel AUX connector

Digital Modulation MG3740A-020
Digital Modulation Retrofit MG3740A-120

Adding the digital modulation function supports generation of digital modulation signals by outputting narrowband digital modulation signals.

Digital Modulation Performance
 RF Modulation Bandwidth: 2 MHz
 Sampling Rate: 20 kHz to 8 MHz

BER Test Function MG3740A-021
BER Test Function Retrofit MG3740A-121

Installs BER measurement function.

*: Also provides AUX Conversion Adapter J1539A for MG3740A-021/121 to use rear-panel AUX connector

CPU/Windows10 Upgrade Retrofit MG3740A-182
CPU/Windows10 Upgrade Retrofit MG3740A-282

This option is for MG3740A units ordered until August 2020. The OS in these MG3740A units is either Windows Embedded Standard 2009 (Windows XP), Windows 7 Professional (MG3740A-029/129) or Windows Embedded Standard 7 (Windows 7).

This option upgrades the currently installed standard CPU and OS of these target units to a faster CPU and the Windows 10 IoT Enterprise LTSC2019. The faster CPU shortens the time required to generate waveform patterns using IQproducer installed in the MG3740A.

*: Due to license restrictions, this option cannot be installed in MG3740A units with the Removable HDD MG3740A-313 (sales discontinued) installed.

Hardware (For 1stRF)

1stRF 100 kHz to 2.7 GHz MG3740A-032
1stRF 100 kHz to 4 GHz MG3740A-034
1stRF 100 kHz to 6 GHz MG3740A-036

Selects 1stRF frequency range.

The frequency range cannot be changed after installation.

High Power Extension for 1stRF MG3740A-041
High Power Extension for 1stRF Retrofit MG3740A-141

Extends signal output setting range upper limit.

MG3740A-041/141 installed and MG3740A-043/143 not installed

Level setting range: Hi limit +30 dBm (Standard +17 dBm)

MG3740A-041/141 not installed and MG3740A-043/143 not installed

Level setting range: Hi limit +25 dBm (Standard +17 dBm)

Low Power Extension for 1stRF MG3740A-042
Low Power Extension for 1stRF Retrofit MG3740A-142

Extends signal output setting range lower limit.

Level setting range: Lo limit -144 dBm (Standard -110 dBm)

Reverse Power Protection for 1stRF MG3740A-043
Reverse Power Protection for 1stRF Retrofit MG3740A-143

Protects signal output connector against reverse input power. (Standard: 2 W nom.)

Max reverse input: 20 W (nom.) (1 MHz < f ≤ 2 GHz)
 10 W (nom.) (2 GHz < f ≤ 6 GHz)

ARB Memory Upgrade 256 Msample for 1stRF MG3740A-045
ARB Memory Upgrade 256 Msample for 1stRF Retrofit MG3740A-145

Upgrades ARB size to 256 Msamples (1 GB)

(standard is 64 Msamples/256 MB)

With MG3740A-048/148 not installed, installs 1 × 256 Msamples

With MG3740A-048/148 installed, installs 2 × 256 Msamples

*: Requires MG3740A-020/120.

Combination of Baseband Signal for 1stRF MG3740A-048
Combination of Baseband Signal for 1stRF Retrofit MG3740A-148

Two internal waveform memories. Selects two waveform patterns per one RF output for setting mutual frequency offset, level offset, delay time, etc., to output 2 signals from 1 RF connector

*: Requires MG3740A-020/120.

Additional Analog Modulation Input for 1stRF MG3740A-050
Additional Analog Modulation Input for 1stRF Retrofit MG3740A-150

Adds additional analog modulation inputs function for 1stRF. Extends to two internal modulation sources (AM/FM/ΦM), and one external modulation source supporting simultaneous two-signal modulation. Installs external signal input connector on rear panel of main unit.

Hardware (For 2ndRF)

2ndRF 100 kHz to 2.7 GHz	MG3740A-062
2ndRF 100 kHz to 4 GHz	MG3740A-064
2ndRF 100 kHz to 6 GHz	MG3740A-066
2ndRF 100 kHz to 2.7 GHz Retrofit	MG3740A-162
2ndRF 100 kHz to 4 GHz Retrofit	MG3740A-164
2ndRF 100 kHz to 6 GHz Retrofit	MG3740A-166

Selects 2ndRF frequency range.

The frequency range cannot be changed after installation.

Can only be retrofitted when 2ndRF not installed.

High Power Extension for 2ndRF	MG3740A-071
High Power Extension for 2ndRF Retrofit	MG3740A-171

Extends signal output setting range upper limit.

MG3740A-071/171 installed and MG3740A-073/173 not installed

Level setting range: Hi limit +30 dBm (Standard +17 dBm)

MG3740A-071/171 not installed and MG3740A-073/173 not installed

Level setting range: Hi limit +25 dBm (Standard +17 dBm)

Low Power Extension for 2ndRF	MG3740A-072
Low Power Extension for 2ndRF Retrofit	MG3740A-172

Extends signal output setting range lower limit.

Level setting range: Lo limit -144 dBm (Standard -110 dBm)

Reverse Power Protection for 2ndRF	MG3740A-073
Reverse Power Protection for 2ndRF Retrofit	MG3740A-173

Protects signal output connector against reverse input power.

(Standard: 2 W nom.)

Max reverse input: 20 W (nom.) (1 MHz < f ≤ 2 GHz),

10 W (nom.) (2 GHz < f ≤ 6 GHz)

ARB Memory Upgrade 256 Msample for 2ndRF	MG3740A-075
ARB Memory Upgrade 256 Msample for 2ndRF Retrofit	MG3740A-175

Upgrades ARB size to 256 Msamples (1 GB).

(standard is 64 Msamples/256 MB)

With MG3740A-078/178 not installed, installs 1 × 256 Msamples

With MG3740A-078/178 installed, installs 2 × 256 Msamples

*: Requires MG3740A-020/120.

Combination of Baseband Signal for 2ndRF	MG3740A-078
Combination of Baseband Signal for 2ndRF Retrofit	MG3740A-178

Two internal waveform memories. Selects two waveform patterns per one RF output for setting mutual frequency offset, level offset, delay time, etc., to output 2 signals from 1 RF connector.

*: Requires MG3740A-020/120.

Additional Analog Modulation Input for 2ndRF	MG3740A-080
Additional Analog Modulation Input for 2ndRF Retrofit	MG3740A-180

Adds additional analog modulation inputs function for 2ndRF. Extends to two internal modulation sources (AM/FM/ΦM), and one external modulation source supporting simultaneous two-signal modulation.

Installs external signal input connector on rear panel of main unit.

Software: IQproducer License

IQproducer is PC application software for generating waveform patterns. The parameters are set using IQproducer and the waveform pattern is created to output the signal by selection at the MG3740A. This one software application includes all the following systems. Since it runs on any PC, the supported functions and parameter range can be verified before purchase.

When outputting a waveform pattern from the MG3740A, no signal is output unless a license for that system is installed in the main unit.

*: Requires MG3740A-020/120.

* Refer to the "IQproducer brochure" for details.

TDMA IQproducer	MX370102A
------------------------	------------------

Sets required parameters for TDMA waveform patterns and generates various waveform patterns. Setting parameters include Modulation, Frame, Slot, Data, Filter, etc. Supports wide application range including public wireless.

Fading IQproducer	MX370107A
--------------------------	------------------

Performs IQ channel fading processing, correlation matrix calculation, AWGN combination. Input data file created by selecting waveform pattern file created with other IQproducer software, and IQ data (ASCII) created with other general-purpose simulation tools.

Easy-to-use Panel

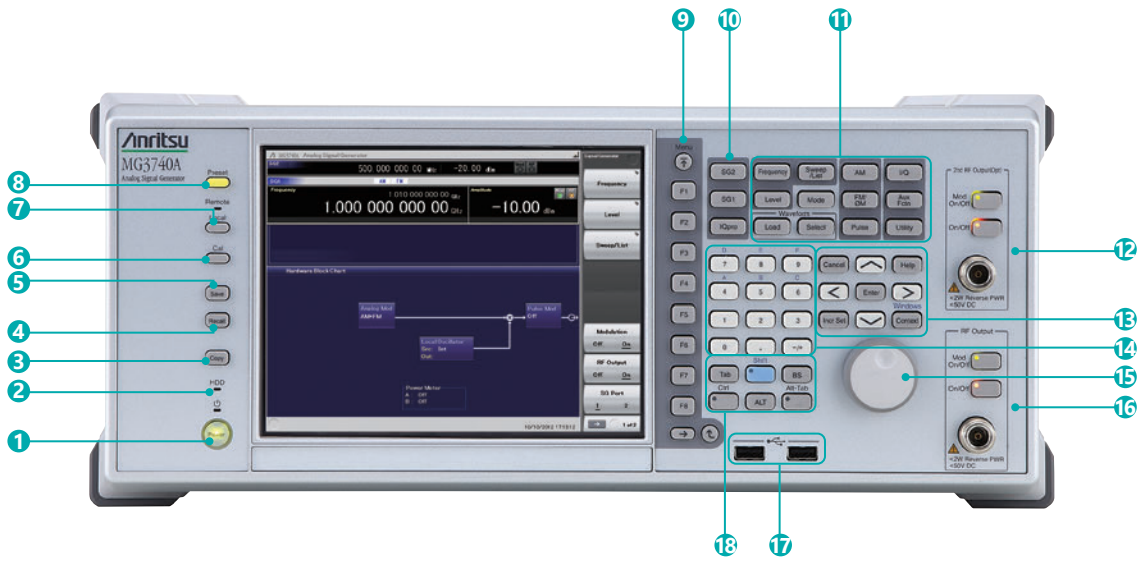

- 1 Power Switch**
Switches between standby status in which AC power is supplied, and operating power-on status. At standby the key lamp is orange; at power-on it is green. To supply power press the switch for 2 seconds or more.
- 2 HDD/SSD Lamp**
Lit when internal storage device (HDD or SSD) being accessed.
- 3 Copy Key**
Copies screen display to file.
- 4 Recall Key**
Displays menu for recalling parameter files.
- 5 Save Key**
Displays menu for saving parameter files.
- 6 Cal Key**
Displays menu for performing calibration.
- 7 Local Key/Remote Lamp**
Local Key: Return remote control via GPIB, Ethernet, USB (B) to local control and enables panel setting.
Remote Lamp: Lit while MG3740A under remote control.
- 8 Preset Key**
Displays Preset menu to initialize parameter settings.
- 9 Function Keys**
Select and execute functions displayed at right edge of display. Displayed functions menus are multi-level with page hierarchy.
- 10 SG1/SG2/IQpro Keys**
SG1: Switches setting target to SG1
SG2: Switches setting target to SG2
IQpro: Starts IQproducer on main unit. IQproducer may not start running for a few seconds to minutes after pressing this key.
- 11 Main Function Keys**
Displays menus for setting and executing main functions: [Frequency], [Level], [Sweep/List], [Mode], [AM], [FM/ΦM], [Pulse], [I/Q], [Load], [Select], [AUX Fctn], [Utility]
- 12 2ndRF Output [MG3740A-062/064/066]**
Mod On/Off: Switched 1stRF/2ndRF modulation On/Off.
Lamp lit during modulation.
On/Off: Switches RF output On/Off.
- 13 Arrow/Enter/Cancel/Help/Incr Set/Context/Windows Keys**
Help: Pressing function key after Help key displays help for pressed function key
Incr Set: Sets increment/decrement steps for each parameter
Context: Performs same operation and right mouse click
Windows: Performs same operation as Windows key
- 14 Ten Key Pad**
Input numeric values for each parameter setting screen.
- 15 Rotary Knob**
Selects and sets displayed items.
- 16 RF Output [MG3740A-032/034/036]**
- 17 USB Connector (Type A)**
- 18 Tab/Alt/BS/Ctrl/Shift/Alt-Tab Key**
Shift key: Executes panel operation indicated by blue characters. Press Shift key and then required key.

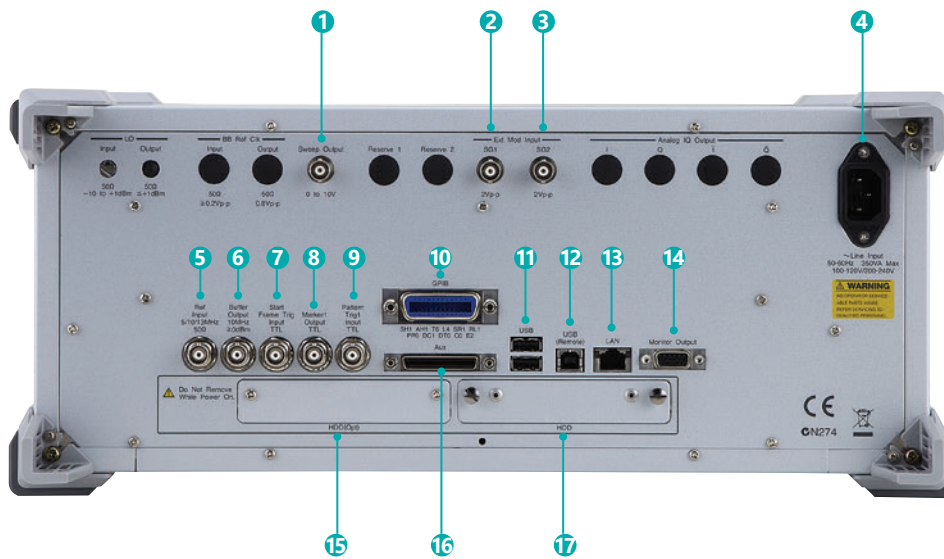

1 Sweep Output

Connector for outputting either 10 V Sweep Signal synchronized with Sweep or Sweep Status signal.

Requires MG3740A-017.

2 Ext Mod Input SG1

Option connector for inputting external signal for additional analog modulation input for the SG1.

Requires MG3740A-050.

3 Ext Mod Input SG2

Option connector for inputting external signal for additional analog modulation input for the SG2.

Requires MG3740A-080.

4 AC Inlet

5 REF Input

Connector for inputting external reference frequency signal (5/10/13 MHz).

6 Buffer Output

Connector for outputting built-in reference frequency signal (10 MHz).

7 Start Frame TRIG Input

Connector (pulled up internally) for inputting external trigger signal.

8 Marker 1 Output

Connector for outputting Marker 1 signal. (Marker 2/3 output from AUX connector. Requires MG3740A-020 and AUX Conversion Adapter J1539A.)

9 Pattern TRIG 1 Input

Connector (pulled up internally) for inputting external trigger signal.

10 GPIB

Connector used for remote control via GPIB.

11 USB Connector (Type A)

Connector for USB memory, keyboard, mouse, etc.

12 USB Connector (Type B)

Connector used for remote control via USB.

13 LAN

Connector for personal computer and network.

14 Monitor Output

RGB connector for external display.

15 HDD (Opt)

Slot for HDD or SSD for saving data. Also supports 2ndary HDD MG3740A-011/111 options.

16 AUX

Connector for following I/O signals.

Requires AUX Conversion Adapter J1539A.

- BER Measurement Signal (Input): Data, CLK, Enable
- Marker Signal (Output): Marker 2, Marker 3
- Pulse Signal for external Pulse Modulation (Input): Pulse Mod
- Signal synchronized with Pulse Modulation signal at PM (Output): Pulse Sync, Pulse Video Out
- Trigger signal at timing of internal Baseband Ref Clock based on Start/Frame trigger (Out): Sync Trigger Out

17 HDD/SSD

Slot for HDD or SSD to save OS, applications, waveform data, etc. Units with an SSD label at the top have an internal SSD; all other units have an internal HDD*1. Also supports Removable HDD, Win10 MG3740A-014/114 options.

*1: MG3740A units ordered from March 2025 have an internal SSD.

Specifications

Refer to the Data Sheet for specification details such as guaranteed setting ranges, etc.

Frequency Setting Range

1stRF

MG3740A-032 9 kHz to 2.7 GHz
 MG3740A-034 9 kHz to 4 GHz
 MG3740A-036 9 kHz to 6 GHz

2ndRF

MG3740A-062 9 kHz to 2.7 GHz
 MG3740A-064 9 kHz to 4 GHz
 MG3740A-066 9 kHz to 6 GHz

Switching Speed (List Mode)

Frequency ≤600 μs
 Level ≤600 μs

Amplitude Setting Range

Options	Setting Range [dBm]	
	without Reverse Power Protection	with Reverse Power Protection
Standard	-110 to +17	-110 to +17
with High-power Extension	-110 to +30	-110 to +25
with Low-power Extension	-144 to +17	-144 to +17
with High-power Extension and Low-power Extension	-144 to +30	-144 to +25

Level Accuracy is assured at high levels (CW)

Frequency Range	Standard	MG3740A-041/071
100 kHz ≤ f < 10 MHz	+5 dBm	+5 dBm
10 MHz ≤ f < 50 MHz	+10 dBm	+10 dBm
50 MHz ≤ f < 400 MHz	+13 dBm	+20 dBm
400 MHz ≤ f ≤ 3 GHz		+23 dBm
3 GHz < f ≤ 4 GHz		+20 dBm
4 GHz < f ≤ 5 GHz		+13 dBm
5 GHz < f ≤ 6 GHz	+11 dBm	+11 dBm

Absolute Level Accuracy (at CW, 18° to 28°C, -110 to +5 dBm)

±0.5 dB (typ.) (100 kHz ≤ f < 50 MHz)
 ±0.5 dB (50 MHz ≤ f ≤ 3 GHz)
 ±0.7 dB (3 GHz < f ≤ 4 GHz)
 ±0.8 dB (4 GHz < f ≤ 6 GHz)

Harmonics

<-30 dBc

Non-Harmonics

Output level ≤+5 dBm, CW, Frequency offset ≥10 kHz

<-62 dBc (100 kHz ≤ f ≤ 187.5 MHz)
 <-68 dBc (187.5 MHz < f ≤ 750 MHz)
 <-62 dBc (750 MHz < f ≤ 1.5 GHz)
 <-56 dBc (1.5 GHz < f ≤ 3 GHz)
 <-50 dBc (3 GHz < f ≤ 6 GHz)

Single Sideband Phase Noise (at CW, 20 kHz offset)

<-140 dBc/Hz (nom.) (100 MHz)
 <-131 dBc/Hz (typ.) (1 GHz)
 <-125 dBc/Hz (typ.) (2 GHz)

Analog Modulation

Amplitude Modulation (Internal Modulation Source)

Depth: 0 to 100% (Linear)
 0 to 10 dB (Log)
 Modulation Frequency: 0.1 Hz to 50 MHz

Frequency Modulation (Internal Modulation Source)

Deviation: 0 Hz to 40 MHz
 Modulation Frequency: 0.1 Hz to 40 MHz, or (50-MHz FM Rate), whichever smaller

Φ-Modulation (Internal Modulation Source)

Deviation angle: 0 to 160 rad., or (40 MHz/ΦM Rate) rad., whichever smaller
 Modulation Frequency: 0.1 Hz to 40 MHz, or (40 MHz/ΦM Deviation), whichever smaller

Pulse Modulation (Internal Modulation Source)

Modulation Frequency: 0.1 Hz to 10 MHz
 Modulation Period: 10 ns to 20 s

Digital Modulation Performance [MG3740A-020 installed]

RF Modulation Bandwidth

2 MHz

ARB Memory Size

64 Msamples (256 MB) [with 1stRF, 2ndRF]
 256 Msamples (1 GB) [MG3740A-045/075]

Sampling Rate

20 kHz to 8 MHz

DAC Resolution

14/15/16 bits

EU Standards (CE Marking)

EMC: 2014/30/EU, EN61326-1, EN61000-3-2
 LVD: 2014/35/EU, EN61010-1
 RoHS: 2011/65/EU, (EU) 2015/863, EN IEC 63000: 2018

EU Standards (UKCA Marking)

EMC: S.I. 2016 No.1091, EN 61326-1, EN61000-3-2
 LVD: S.I. 2016 No.1101, EN 61010-1
 RoHS: S.I. 2012 No.3032, EN IEC 63000:2018

Dimensions, Weight

177 (H) × 426 (W) × 390 (D) mm
 ≤13.7 kg (with 1stRF, excluding other option)

Power Requirements

100 V(ac) to 120 V(ac), 200 V(ac) to 240 V(ac)
 50 Hz to 60 Hz

Options Configuration Guide

The following table shows the recommended option combinations.

Type	MG3740A-No	Retrofit	Name	032	034	036	041	042	043	045	048	050	062	064	066	071	072	073	075	078	080	001	002	011	014	017	020	021	182
1stRF	MG3740A-032		1stRF 100 kHz to 2.7 GHz		*1	*1																							
1stRF	MG3740A-034		1stRF 100 kHz to 4 GHz	*1		*1																							
1stRF	MG3740A-036		1stRF 100 kHz to 6 GHz	*1	*1																								
1stRF	MG3740A-041	141	High Power Extension for 1stRF																										
1stRF	MG3740A-042	142	Low Power Extension for 1stRF																										
1stRF	MG3740A-043	143	Reverse Power Protection for 1stRF																										
1stRF	MG3740A-045	145	ARB Memory Upgrade 256 Msample for 1stRF																										*3
1stRF	MG3740A-048	148	Combination of Baseband Signal for 1stRF																										*3
1stRF	MG3740A-050	150	Additional Analog Modulation Input for 1stRF																										
2ndRF	MG3740A-062	162	2ndRF 100 kHz to 2.7 GHz												*2	*2													
2ndRF	MG3740A-064	164	2ndRF 100 kHz to 4 GHz										*2		*2														
2ndRF	MG3740A-066	166	2ndRF 100 kHz to 6 GHz										*2	*2															
2ndRF	MG3740A-071	171	High Power Extension for 2ndRF																										
2ndRF	MG3740A-072	172	Low Power Extension for 2ndRF																										
2ndRF	MG3740A-073	173	Reverse Power Protection for 2ndRF																										
2ndRF	MG3740A-075	175	ARB Memory Upgrade 256 Msample for 2ndRF																										*3
2ndRF	MG3740A-078	178	Combination of Baseband Signal for 2ndRF																										*3
2ndRF	MG3740A-080	180	Additional Analog Modulation Input for 2ndRF																										
Common	MG3740A-001	101	Rubidium Reference Oscillator																										
Common	MG3740A-002	102	High Stability Reference Oscillator																										
Common	MG3740A-011	111	2ndary HDD																										
Common	MG3740A-014	114*4	Removable HDD, Win10																										
Common	MG3740A-017	117	Universal Input/Output																										
Common	MG3740A-020	120	Digital Modulation																										
Common	MG3740A-021	121	BER Test Function																										
Common	MG3740A-182/182	182	CPU/Windows10 Upgrade Retrofit*5																										

- *1: Only one of 2.7 GHz, 4 GHz, and 6 GHz options. Install any one 1stRF option. Retrofitting one of these options disables previously installed option.
- *2: Only one of 2.7 GHz, 4 GHz, and 6 GHz options. Retrofitting one of these options disables previously installed option. Install any one 2ndRF option. Can be retrofitted only when 2ndRF not installed.
- *3: Requires Digital Modulation (MG3740A-020/120).
- *4: The CPU/Windows10 Upgrade Retrofit MG3740A-182/282 option is required when the MG3740A OS is not Windows 10.
- *5: Replace the MG3740A CPU board with either Windows Embedded Standard 2009 (Windows XP), Windows 7 professional (MG3740A-029/129) or Windows Embedded Standard 7 (Windows 7) and upgrade the operating system to Windows 10 IoT Enterprise LTSC2019.
 - WES2009 (Windows XP) or Windows 7 Professional (MG3740A-029/129) is installed in MG3740A units ordered until May 2018.
 - WES7 (Windows 7) is installed in MG3740A units ordered from June 2018 which have a label indicating C1 attached near the serial number.
 - Windows 10 is installed in MG3740A units ordered from September 2020 and has a label indicating C2 attached near the serial number.

Maximum Waveform Pattern Size and Required Options for Simultaneous Use

1stRF (MG3740A-032/034/036)

Combination of Baseband Signal (MG3740A-048)	ARB Memory Upgrade 256 Msample (MG3740A-045)	
	W/O	With MG3740A-045
W/O	64 Msamples × 1 pc	256 Msamples × 1 pc
With MG3740A-048*	64 Msamples × 2 pcs 128 Msamples × 1 pc	256 Msamples × 2 pcs 512 Msamples × 1 pc

2ndRF (MG3740A-062/064/066)

Combination of Baseband Signal (MG3740A-078)	ARB Memory Upgrade 256 Msample (MG3740A-075)	
	W/O	With MG3740A-075
W/O	64 Msamples × 1 pc	256 Msamples × 1 pc
With MG3740A-078*	64 Msamples × 2 pcs 128 Msamples × 1 pc	256 Msamples × 2 pcs 512 Msamples × 1 pc

*: The Baseband Signal Combine option supports two ARB memories and can either set two different waveform patterns or combine them as one memory to support one large waveform pattern.

Ordering Information

Please specify the model/order number, name and quantity when ordering.

The names listed in the chart below are Order Names. The actual name of the item may differ from the Order Name.

Model/Order No.	Name	Remarks
MG3740A	Main Unit Analog Signal Generator	
P0031A	Standard Accessories Power Cord: 1 pc USB Memory Install CD-ROM	USB2.0 Flash Driver, ≥256 MB Operation manual (PDF) and application software (IQproducer)
MG3740A-001 MG3740A-002 MG3740A-011 MG3740A-014	Options (Common Parts) Rubidium Reference Oscillator High Stability Reference Oscillator 2ndary HDD Removable HDD, Win10	Select when ordering main unit, aging rate: $\pm 1 \times 10^{-10}$ /month Select when ordering main unit, aging rate: $\pm 1 \times 10^{-7}$ /year Select when ordering main unit, spare storage device for saving user data without Windows OS Select when ordering main unit. This secondary storage device option can be installed in place of the standard built-in storage device containing user data when repairing or calibrating the MG3740A to prevent risks of user-data leaks when user data must not be taken offsite.
MG3740A-017	Universal Input/Output	Select when ordering main unit, Adds BNC connectors for Sweep Output signal (only supports SG1) to rear panel of main unit, includes AUX Conversion Adapter J1539A
MG3740A-020	Digital Modulation	Select when ordering main unit, Built-in Digital Modulation function. Digital modulation Performance: - RF modulation bandwidth: 2 MHz - Sampling rate: 20 kHz to 8 MHz
MG3740A-021	BER Test Function	Select when ordering main unit, Built-in BER measurement, Bit Rate: 100 bps to 40 Mbps J1539A AUX Conversion Adapter required for Data/Clock/Enable signal input
MG3740A-101 MG3740A-102 MG3740A-111 MG3740A-114	Rubidium Reference Oscillator Retrofit High Stability Reference Oscillator Retrofit 2ndary HDD Retrofit Removable HDD, Win10 Retrofit	Retrofitted to shipped MG3740A Retrofitted to shipped MG3740A Retrofitted to shipped MG3740A Retrofitted to shipped MG3740A
MG3740A-214	Removable HDD, Win10 Retrofit	When retrofitting the MG3740A-114/214, the MG3740A main unit without the removed storage device can be returned to Anritsu. The CPU/Windows10 Upgrade Retrofit MG3740A-182/282 option is required when the MG3740A OS is not Windows 10. Retrofitted to shipped MG3740A When retrofitting the MG3740A-114/214, the MG3740A main unit without the removed storage device can be returned to Anritsu. The CPU/Windows10 Upgrade Retrofit MG3740A-182/282 option is required when the MG3740A OS is not Windows 10. MG3740A-2xx is the option for customers to upgrade at their nearest local service center outside Japan.
MG3740A-117 MG3740A-120 MG3740A-121	Universal Input/Output Retrofit Digital Modulation Retrofit BER Test Function Retrofit	Retrofitted to shipped MG3740A Retrofitted to shipped MG3740A Retrofitted to shipped MG3740A
MG3740A-182	CPU/Windows10 Upgrade Retrofit	The CPU/Windows 10 Upgrade Retrofit MG3740A-182 is required when retrofitting the MG3740A-121 to the MG3740A with built-in WES2009 (Windows XP) or Windows 7 Professional (MG3740A-029/129). Refer to the description in the Options Configuration Guide for how to determine the built-in OS. Retrofitted to shipped MG3740A
MG3740A-282	CPU/Windows10 Upgrade Retrofit	Due to OS license restrictions, this option cannot be installed in MG3740A units with Removable HDD MG3740A-313 (sales discontinued) installed. Retrofitted to shipped MG3740A MG3740A-2xx is the option for customers to upgrade at their nearest local service center outside Japan. Due to OS license restrictions, this option cannot be installed in MG3740A units with Removable HDD MG3740A-313 (sales discontinued) installed.
MG3740A-032	(For 1stRF) 1stRF 100 kHz to 2.7 GHz	Select when ordering main unit, select 1stRF frequency range, frequency cannot be changed after installation
MG3740A-034	1stRF 100 kHz to 4 GHz	Select when ordering main unit, select 1stRF frequency range, frequency cannot be changed after installation
MG3740A-036	1stRF 100 kHz to 6 GHz	Select when ordering main unit, select 1stRF frequency range, frequency cannot be changed after installation
MG3740A-041	High Power Extension for 1stRF	Select when ordering main unit, increases upper limit of output signal power setting range
MG3740A-042	Low Power Extension for 1stRF	Select when ordering main unit, increases lower limit of output signal power setting range
MG3740A-043	Reverse Power Protection for 1stRF	Select when ordering main unit, prevents damage caused by reverse input to output connector
MG3740A-045	ARB Memory Upgrade 256 Msample for 1stRF	Select when ordering main unit, expands ARB memory capacity. Requires MG3740A-020.
MG3740A-048	Combination of Baseband Signal for 1stRF	Select when ordering main unit, adds baseband combine function. Requires MG3740A-020.
MG3740A-050	Additional Analog Modulation Input for 1stRF	Select when ordering main unit, Adds BNC connector for inputting external signals to rear panel of main unit.
MG3740A-141	High Power Extension for 1stRF Retrofit	Retrofitted to shipped MG3740A
MG3740A-142	Low Power Extension for 1stRF Retrofit	Retrofitted to shipped MG3740A
MG3740A-143	Reverse Power Protection for 1stRF Retrofit	Retrofitted to shipped MG3740A
MG3740A-145	ARB Memory Upgrade 256 Msample for 1stRF Retrofit	Retrofitted to shipped MG3740A. Requires MG3740A-020/120.
MG3740A-148	Combination of Baseband Signal for 1stRF Retrofit	Retrofitted to shipped MG3740A. Requires MG3740A-020/120.
MG3740A-150	Additional Analog Modulation Input for 1stRF Retrofit	Retrofitted to shipped MG3740A

Ordering Information

Model/Order No.	Name	Remarks
MG3740A-062	(For 2ndRF) 2ndRF 100 kHz to 2.7 GHz	Select when ordering main unit, select 2ndRF frequency range, frequency cannot be changed after installation
MG3740A-064	2ndRF 100 kHz to 4 GHz	Select when ordering main unit, select 2ndRF frequency range, frequency cannot be changed after installation
MG3740A-066	2ndRF 100 kHz to 6 GHz	Select when ordering main unit, select 2ndRF frequency range, frequency cannot be changed after installation
MG3740A-071	High Power Extension for 2ndRF	Select when ordering main unit, increases upper limit of output signal power setting range
MG3740A-072	Low Power Extension for 2ndRF	Select when ordering main unit, increases lower limit of output signal power setting range
MG3740A-073	Reverse Power Protection for 2ndRF	Select when ordering main unit, prevents damage caused by reverse input to output connector
MG3740A-075	ARB Memory Upgrade 256 Msample for 2ndRF	Select when ordering main unit, expands ARB memory capacity. Requires MG3740A-020.
MG3740A-078	Combination of Baseband Signal for 2ndRF	Select when ordering main unit, adds baseband combine function. Requires MG3740A-020.
MG3740A-080	Additional Analog Modulation Input for 2ndRF	Select when ordering main unit, Adds BNC connector for inputting external signals to rear panel of main unit.
MG3740A-162	2ndRF 100 kHz to 2.7 GHz Retrofit	Retrofitted to shipped MG3740A when 2ndRF not installed
MG3740A-164	2ndRF 100 kHz to 4 GHz Retrofit	Retrofitted to shipped MG3740A when 2ndRF not installed
MG3740A-166	2ndRF 100 kHz to 6 GHz Retrofit	Retrofitted to shipped MG3740A when 2ndRF not installed
MG3740A-171	High Power Extension for 2ndRF Retrofit	Retrofitted to shipped MG3740A
MG3740A-172	Low Power Extension for 2ndRF Retrofit	Retrofitted to shipped MG3740A
MG3740A-173	Reverse Power Protection for 2ndRF Retrofit	Retrofitted to shipped MG3740A
MG3740A-175	ARB Memory Upgrade 256 Msample for 2ndRF Retrofit	Retrofitted to shipped MG3740A. Requires MG3740A-020/120.
MG3740A-178	Combination of Baseband Signal for 2ndRF Retrofit	Retrofitted to shipped MG3740A. Requires MG3740A-020/120.
MG3740A-180	Additional Analog Modulation Input for 2ndRF Retrofit	Retrofitted to shipped MG3740A
	Maintenance Service	
MG3740A-ES210	2 Years Extended Warranty Service	
MG3740A-ES310	3 Years Extended Warranty Service	
MG3740A-ES510	5 Years Extended Warranty Service	
	Softwares (IQproducer)	
MX370102A	TDMA IQproducer	(License for IQproducer)
MX370107A	Fading IQproducer	IQproducer software, license for main unit, manual (PDF)
	Optional Accessories	
W3580AE	MG3710A/MG3710E/MG3740A Operation Manual (Main Unit)	Booklet, for MG3710A/MG3710E/MG3740A Main Unit (Operation, Remote Control)
W2496AE	MG3710A/MG3710E/MG3740A Operation Manual (IQproducer)	Booklet, for IQproducer (Operation for Common Parts)
W2916AE	MX370102A Operation Manual	Booklet, for TDMA IQproducer
W2995AE	MX370107A Operation Manual	Booklet, for Fading IQproducer
J1539A	AUX Conversion Adapter	Converts MG3740A rear-panel AUX connector to BNC connector
Z1572A	Installation Kit	Requires when retrofitting hardware options or installing IQproducer/Waveform Pattern
MA24105A	Inline Peak Power Sensor	350 MHz to 4 GHz, Inline type, with USB A to micro-B Cable
MA24106A	USB Power Sensor	50 MHz to 6 GHz, with USB A to mini-B Cable
MA24108A	Microwave USB Power Sensor	10 MHz to 8 GHz, with USB A to micro-B Cable
MA24118A	Microwave USB Power Sensor	10 MHz to 18 GHz, with USB A to micro-B Cable
MA24126A	Microwave USB Power Sensor	10 MHz to 26 GHz, with USB A to micro-B Cable
K240B	Power Divider (K connector)	DC to 26.5 GHz, K-J, 50 Ω, 1 Wmax
J0576B	Coaxial Cord, 1.0 m	N-P · 5D-2W · N-P
J0576D	Coaxial Cord, 2.0 m	N-P · 5D-2W · N-P
J0127A	Coaxial Cord, 1.0 m	BNC-P · RG-58A/U · BNC-P
J0127B	Coaxial Cord, 2.0 m	BNC-P · RG-58A/U · BNC-P
J0127C	Coaxial Cord, 0.5 m	BNC-P · RG-58A/U · BNC-P
J0322A	Coaxial Cord, 0.5 m	SMA-P · SMA-P, DC to 18 GHz, 50 Ω
J0322B	Coaxial Cord, 1.0 m	SMA-P · SMA-P, DC to 18 GHz, 50 Ω
J0322C	Coaxial Cord, 1.5 m	SMA-P · SMA-P, DC to 18 GHz, 50 Ω
J0322D	Coaxial Cord, 2.0 m	SMA-P · SMA-P, DC to 18 GHz, 50 Ω
J0004	Coaxial Adapter	N-P · SMA-J Conversion Adapter, DC to 12.4 GHz
J1261B	Ethernet Cable (Shield Type)	Straight-through, 3 m
J1261D	Ethernet Cable (Shield Type)	Crossover, 3 m
J0008	GPIO Cable, 2.0 m	
B0635A	Rack Mount Kit	EIA
B0657A	Rack Mount Kit (JIS)	JIS
B0636C	Carrying Case	Hard type. With Casters and Front Cover B0671A
B0671A	Front Cover for 1MW4U	
Z0541A	USB Mouse	

Requires Installation Kit Z1572A when retrofitting options or installing IQproducer/Waveform Pattern.

The instruction manuals are published on our website except some.

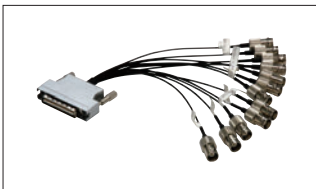

J1539A AUX Conversion Adapter



MA24106A USB Power Sensor



B0636C Carrying Case
(Hard type, with casters)



B0671A Front Cover for 1MW4U

Appendix: Compatibility with MG3641A/MG3642A

The MG3740A Analog Signal Generator replaces the older MG3641A/MG3642A Synthesized Signal Generator. The differences in the main functions of the MG3641A/MG3642A and MG3740A are listed in the following table.

Function difference between MG3641A/MG3642A and MG3740A

Synthesized Signal Generator MG3641A/MG3642A	Analog Signal Generator MG3740A
Frequency range MG3641A: 125 kHz to 1040 MHz MG3642A: 125 kHz to 2080 MHz	Frequency range MG3740A-032: 100 kHz to 2.7 GHz MG3740A-034: 100 kHz to 4 GHz MG3740A-036: 100 kHz to 6 GHz
SSB phase noise [1 GHz, 20 kHz Offset] <-130 dBc/Hz	SSB phase noise [1 GHz, 20 kHz Offset] <-131 dBc/Hz (typ.)
Non-harmonics spurious -100 dBc [15 kHz offset]	Non-harmonics spurious -68 dBc (-76 dBc typ.) [187.5 kHz to 750 MHz, 10 kHz offset]
Pulse modulation On/Off ratio >80 dB	Pulse modulation On/Off ratio >70 dB
Level isolation mode (Controls distortion using large isolation between SGs at IM measurement, etc.)	Distortion control by setting optimize S/N function to On (similar effectiveness)
Level safety mode (Controls high-level signal spikes)	No signal spike generation (Uses built-in electronic attenuator)
Level setting units dBm, dBμ (emf), dBμ (term), V (emf), V (term), mV (emf), mV (term), μV (emf), μV (term)	Level setting units dBm, dBμV (emf), dBμV (term)
Reverse polarity by setting negative value for AM/FM modulation rate	No
Memory function (Saves and reads setting conditions)	Uses parameter Save/Recall function
Internal modulation source: Three AF sources	AM, FM/ΦM: each two sources [Standard] One internal AF source [with MG3740A-050/080] Supports selection of internal second AF signals and external modulation input signals.
External modulation source: Two external sources	One external source [with MG3740A-050/080]
Impedance setting for external pulse modulation input [50Ω, 600Ω, TTL]	No [only TTL]
AF out connector	No
Trigger Function (Triggers pre-registered panel key operation sequence to execute)	No
Marker Frequency Setting (Outputs High (TTL) when actual sweep frequency matches marker frequency)	No
Tracking control using Only mode	No
Frequency sweep: Start/Stop setting Linear: Point number setting Linear: Step size setting Log: 1% fixed multiplier	Compatible No No
Frequency sweep: Center/Span setting Linear: Point number setting Linear: Step size setting	Compatible No
Level sweep: Start/Stop setting Point number setting Step size setting	Compatible No
Level sweep: Center/Span setting Point number setting Step size setting	No No
Memory sweep Start/Stop address setting	No

Typical (typ.): Performance not warranted. Must products meet typical performance.

Nominal (nom.): Values not warranted. Included to facilitate application of product.

Measured (meas): Performance not warranted. Data actually measured by randomly selected measuring instruments.

Trademarks:

- IQproducer™ is a registered trademark of Anritsu Corporation.
- MATLAB® is a registered trademark of The MathWorks, Inc.
- CDMA2000® is a registered trademark of the Telecommunications Industry Association (TIA-USA).
- The Bluetooth® mark and logos are owned by Bluetooth SIG, Inc. and are used by Anritsu under license.
- Pentium® is registered trademarks of Intel Corporation or its subsidiaries in the USA and other countries.
- Windows® is a registered trademark of Microsoft Corporation in the USA and other countries.
- Other companies, product names and service names are registered trademarks of their respective companies.



Specifications are subject to change without notice.

• **United States**

Anritsu Americas Sales Company

490 Jarvis Drive, Morgan Hill, CA 95037-2809, U.S.A.
Phone: +1-800-Anritsu (1-800-267-4878)

• **Canada**

Anritsu Electronics Ltd.

Americas Sales and Support

490 Jarvis Drive, Morgan Hill, CA 95037-2809, U.S.A.
Phone: +1-800-Anritsu (1-800-267-4878)

• **Brazil**

Anritsu Eletrônica Ltda.

Praça Amadeu Amaral, 27 - 1 Andar
01327-010 - Bela Vista - Sao Paulo - SP, Brazil
Phone: +55-11-3283-2511
Fax: +55-11-3288-6940

• **Mexico**

Anritsu Company, S.A. de C.V.

Bldv Miguel de Cervantes Saavedra #169 Piso 1, Col. Granada
Mexico, Ciudad de Mexico, 11520, MEXICO
Phone: +52-55-4169-7104

• **United Kingdom**

Anritsu EMEA Limited

900 Capability Green, Luton, Bedfordshire, LU1 3LU, U.K.
Phone: +44-1582-433200
Fax: +44-1582-731303

• **France**

Anritsu SA

12 avenue du Québec, Immeuble Goyave,
91140 VILLEBON SUR YVETTE, France
Phone: +33-1-60-92-15-50

• **Germany**

Anritsu GmbH

Nemetschek Haus, Konrad-Zuse-Platz 1,
81829 München, Germany
Phone: +49-89-442308-0
Fax: +49-89-442308-55

• **Italy**

Anritsu S.R.L.

Spaces Eur Arte, Viale dell'Arte 25, 00144 Roma, Italy
Phone: +39-6-509-9711

• **Sweden**

Anritsu AB

Kistagången 20 B, 2 tr, 164 40 Kista, Sweden
Phone: +46-8-534-707-00

• **Finland**

Anritsu AB

Technopolis Aviapolis, Teknobulevardi 3-5 (D208.5),
FI-01530 Vantaa, Finland
Phone: +358-20-741-8100

• **Denmark**

Anritsu A/S

c/o Regus Winghouse, Ørestads Boulevard 73, 4th floor,
2300 Copenhagen S, Denmark
Phone: +45-7211-2200

• **Spain**

Anritsu EMEA GmbH

Representation Office in Spain

Calle Manzanares 4, Primera planta, 28005 Madrid, Spain
Phone: +34-91-572-6761

• **Austria**

Anritsu EMEA GmbH

Am Belvedere 10, A-1100 Vienna, Austria
Phone: +43-(0)1-717-28-710

• **United Arab Emirates**

Anritsu A/S

Office No. 164, Building 17, Dubai Internet City
P. O. Box – 501901, Dubai, United Arab Emirates
Phone: +971-4-3758479

• **India**

ANRITSU INDIA PRIVATE LIMITED

6th Floor, Indiqube ETA, No.38/4, Adjacent to EMC2,
Doddanekundi, Outer Ring Road, Bengaluru – 560048, India
Phone: +91-80-6728-1300
Fax: +91-80-6728-1301

• **Singapore**

ANRITSU PTE LTD

1 Jalan Kilang Timor, #07-04/06 Pacific Tech Centre
Singapore 159303
Phone: +65-6282-2400
Fax: +65-6282-2533

• **Vietnam**

ANRITSU COMPANY LIMITED

16th Floor, Peakview Tower, 36 Hoang Cau Street, O Cho Dua Ward,
Dong Da District, Hanoi, Vietnam
Phone: +84-24-3201-2730

• **P.R. China (Shanghai)**

Anritsu (China) Co., Ltd.

Room 2301-2303, Tower A, New Caohejing International Business
Center No. 391 Gui Ping Road, Shanghai, 200233, P.R. China
Phone: +86-21-6237-0898
Fax: +86-21-6237-0899

• **P.R. China (Hong Kong)**

ANRITSU COMPANY LIMITED

Unit 1302, 13th Floor, New East Ocean Center,
No.9 Science Museum Road, TsimShaTsui East,
Kowloon, Hong Kong
Phone: +852-2301-4980
Fax: +852-2301-3545

• **Japan**

Anritsu Corporation

8-5, Tamura-cho, Atsugi-shi, Kanagawa, 243-0016 Japan
Phone: +81-46-296-6509
Fax: +81-46-225-8352

• **Korea**

Anritsu Corporation Limited

8F, A TOWER, 20, Gwacheondaero 7-gil, Gwacheon-si,
Gyeonggi-do, 13840, Republic of Korea
Phone: +82-2-6259-7300
Fax: +82-2-6259-7301

• **Australia**

Anritsu Pty Ltd

Unit 20, 21-35 Ricketts Road, Mount Waverley, Victoria 3149, Australia
Phone: +61-3-9558-8177
Fax: +61-3-9558-8255

• **Taiwan**

ANRITSU COMPANY, INC.

7F, No. 316, Sec. 1, NeiHu Rd., Taipei 114, Taiwan
Phone: +886-2-8751-1816
Fax: +886-2-8751-1817